

Polarization of 660 mev Protons Scattered by Nuclei

M. G. MESHCHERIAKOV, S. B. NURUSHEV AND G. D. STOLETOV

Institute for Nuclear Problems, Academy of Sciences, USSR

(Submitted to JETP editor June 1, 1956)

J. Exptl. Theoret. Phys. (U.S.S.R.) 31, 361-370 (September, 1956)

Results of experiments on double scattering of 660 mev protons are described. The angular dependence of the asymmetry was measured in scattering of polarized 565 and 635 mev protons from beryllium. The polarization in quasi-elastic p - p scattering at 635 mev was measured by the method of coupled telescopes. The results of the measurements are given for the asymmetry in scattering of protons at 9° from carbon, aluminum, lead and bismuth and a detection limit of 230 and 620 mev.

1. INTRODUCTION

UNTIL now the effects of polarization of protons in scattering by nuclei were detected up to 439 mev in experiments involving double scattering of the primary unpolarized beam.¹⁻⁶ It was found that the polarization of protons reaches a maximum at energies and angles corresponding to the diffraction scattering of protons by nuclei. The magnitude and directions of the polarization of the spin may be qualitatively explained by assuming the same spin orbit interaction between the fast protons and the nucleus which is assumed in the nuclear shell model.⁷⁻¹⁰

The present work is concerned with the polarization effects in scattering of 660 mev protons by nuclei.

2. PRODUCTION OF THE BEAM OF POLARIZED PROTONS

The first scattering of protons was carried out inside of a 6 m synchrocyclotron chamber from a 4 cm beryllium target (polarizer), placed in the path of the circulating beam of 660 mev protons. It is evident that only diffraction scattering of protons, single quasi-elastic p - p scattering, and p - n scattering without exchange at small angles do not lead to losses of energy for the protons. In the first case the scattered protons are concentrated in a narrow cone directed forward with an apex angle of the order of λ/R (λ is the wavelength of the incident proton, R is the radius of the scattering nucleus). Their energy is slightly smaller than the initial energy only if such collisions are not accompanied by transitions of the nuclei into excited states. In the second case there is no unique correlation between the scattering angle and the energy of the particle because of the zero-point vibrations of the nucleons in the nucleus. As a result the scattered nucleons have a rather broad energy distribution whose maximum is at about the same energy as for free collisions. The general character of the angular distribution of

quasi-elastically scattered nucleons should be the same as for elastic scattering of nucleons. Nuclear cascades and nucleon collisions connected with generation of π -mesons are accompanied by emission of protons whose energies are considerably smaller than the energies of quasi-elastically scattered protons.

The direct measurement of the energy distribution of the first scattered protons was made in our laboratory using an analyzing magnet to obtain the momentum spectrum of protons issuing from the beryllium target.¹¹ One of the first results of these measurements was a discovery at angles 7.3° and 12.2° (relative to the primary beam) of a maximum corresponding to diffraction scattered protons superimposed in the upper energy region on a dome-shaped distribution of the quasi-elastically scattered protons. At the angles of 18° , 24° and 30° in the high energy region of the spectrum, only quasi-elastically scattered protons were found.

In the present experiments two polarized beams were used. Their trajectories are shown in Fig. 1. One of them (beam A) was composed only of protons experiencing quasi-elastic scattering to the left at an angle of 18° . Inelastically scattered protons and protons emitted in a nuclear cascade process were removed from the beam by the analyzing action of the fringing magnetic field of the synchrocyclotron. The beam passed through a 3.6 m long steel collimator K_1 , located in 4 m reinforced concrete shielding wall, and then fell on the second target (analyzer). The flux density of protons was approximately 10^4 protons/cm² at the location of the analyzer. The solid curve of Fig. 2 gives the results of the measurements of absorption of protons in copper for beam A . From these results it follows that the average energy of the protons is 565 mev and the maximum energy deviation ± 60 mev. Taking into account the slowing down of the protons in the analyzer the average energy is the same as for p - p scattering

of free nucleons at an 18° angle.

The beam B , composed of protons scattered to the left at an angle of 9° , was formed inside of the vacuum chamber of the synchrocyclotron using a steel collimator K_2 which was also a magnetic

channel. The beam was deflected 9° to the right by a steering magnet after its exit out of the vacuum chamber. All these operations increased the monochromaticity of the beam and excluded the possibility of particles falling into the shielded

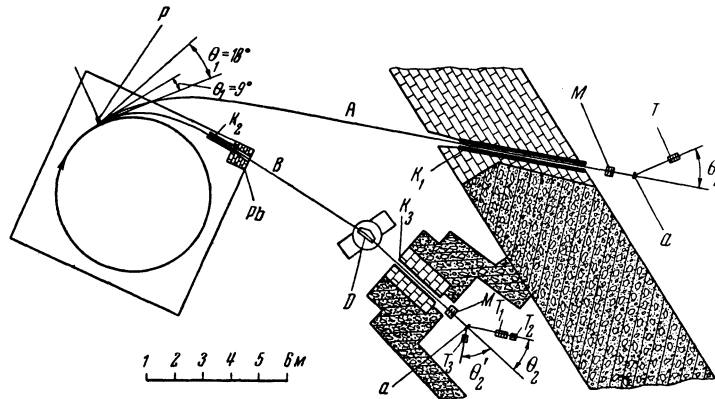

FIG. 1. Plane view of the experimental arrangement. P is the polarizer; a the analyzer; D the steering magnet; K_1 , K_2 , K_3 the collimators; T , T_1 , T_2 , T_3 telescopes.

cave directly from the synchrocyclotron chamber through the collimator K_3 . The proton density behind the collimator K_3 at the location of the analyzer was approximately 10^5 protons/cm² sec. Here the proton energy, determined by the range of protons in copper, was found to be 242 gm/cm² (Fig. 2) which corresponds to 635 mev with a maximum deviation ± 15 mev. Under the given experimental conditions, diffraction-scattered

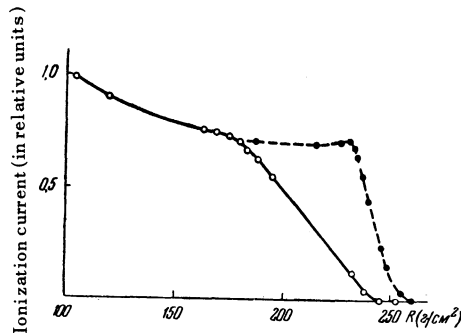

FIG. 2. Absorption curves of protons in copper. The solid curve shows the data for beam A , the dotted line for beam B .

protons of the same energy should be emitted at an angle of 9° . Assuming that the shape of the spectrum of the quasi-elastically scattered protons is similar at the angle of 24° to that at small angles, it was possible to separate for the spectra at 7.3° and 12.2° the diffraction peak from the continuous distribution. From the ratio of the areas

under the appropriate curves it was also possible to evaluate the admixture of the quasi-elastically scattered protons in an energy interval 30 mev wide whose center coincides with the maximum of the diffraction peak. For the above angles, the admixture turned out to be 9% and 28% from which, by interpolation, the admixture of quasi-elastically scattered protons in beam B was calculated to be about 16%. Figure 3 gives the spectrum of the first scattered protons separated in this manner for the angles 7.3° and 12.2° .

The trajectories of beams A and B inside the synchrocyclotron chamber and in the fringing magnetic field were traced by means of a thin, stretched current carrying wire. A small mirror was attached to this wire at the point where the wire was fixed to the polarizer. As the wire was moved from the trajectory of the circulating beam to the direction of the trajectory of the scattered proton beam, the rotation angle of the mirror was measured. Collimators were thus located on the axes of the beams with an accuracy of about $\pm 2'$. The beam diameter near the analyzer was usually about 3 cm. The uniformity of the current density in the cross section of the beam was verified with photoemulsions.

3. METHODS OF MEASUREMENTS

The second scattered protons were detected by telescopes consisting of two and three scintillation counters set for coincidence counts. The

toluene crystals, 3 mm thick, were surrounded by aluminum foil shields so that the scintillation light was reflected onto the cathode of the photo-multiplier. The photo-multiplier was very carefully shielded from stray magnetic fields by soft iron and Permalloy. The resolution time of the coincidence channels of the telescopes was about 3×10^8 sec. The efficiency of the proton detection

was close to 100%. The detection limit of the proton energy was determined by the thickness of a copper absorber in the telescope.

The apparatus for the second scattering was composed of a round bevel protractor disc 800 mm in diameter, with the target-analyzer placed at the center. With remote control equipment the target could be removed from the beam and be replaced by

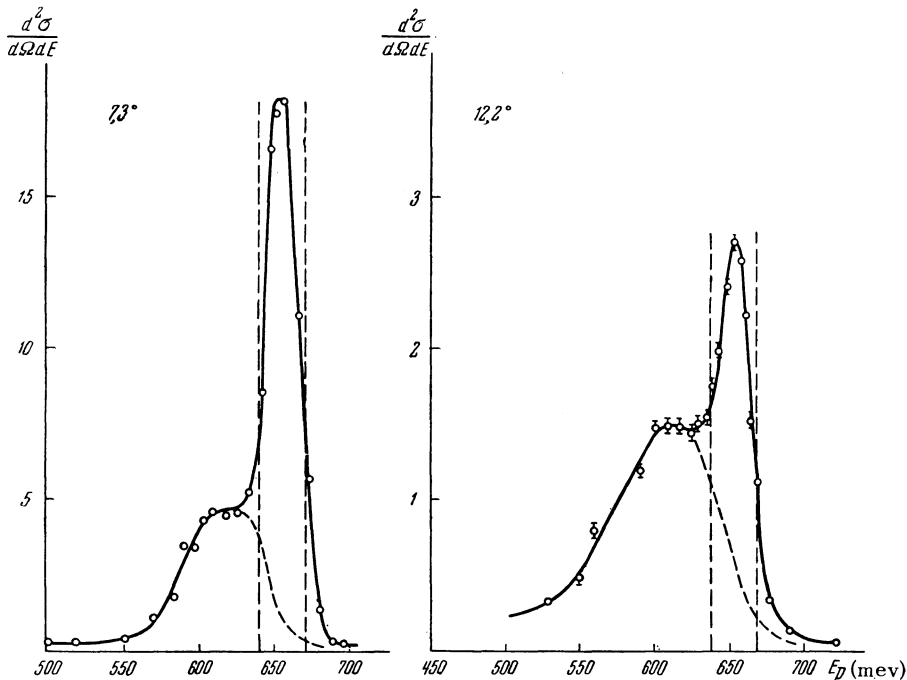

FIG. 3. Energy spectrum of 660 mev protons scattered by Be target;
 $d^2 \sigma / d\Omega dE$ in arbitrary units.

another target. The telescopes were placed on supports which could be rotated in the plane of scattering about an axis passing through the analyzer and fixed at a given angle relative to the proton beam. The alignment of the telescopes with the trajectory of the beam was within $\pm 3'$ and was regularly checked photographically while the measurements were being carried out. In the same manner the position of the counters in the scattering plane was checked. The intensity of the beams was recorded by an ionization chamber filled with argon and an integrating amplifier of the resulting d. c. current.

The execution of the experiments fundamentally reduced to the measurement of the angular asymmetry $\epsilon = (L - R) / (L + R)$ where L and R are the normalized counting rates of the protons second scattered to the left and to the right at the same angle relative to the direction of the beam of the first scattered protons. The two scattering planes coincided. At large angles the counting rate of

triple coincidences with the analyzer removed from the beam did not exceed 1% of the effect of the analyzer. The background increased as a rule with a decrease in the angle because of the scattering of protons in the walls of the collimator.

4. POLARIZATION OF 565 MEV PROTONS*

To determine the angular dependence of the asymmetry of the second scattered protons, scattered at an angle of 18° from a beryllium target bombarded by 660 mev protons, measurements were made with beam A at angles θ_2 from 6° to 30° in the laboratory system of coordinates. A beryllium disc 30 mm thick and 65 mm in diameter was used as an analyzer. In the majority of measurements the second scattered protons were detected in a solid angle 2×10^{-3} steradian by a single

*The experiments described in this section were carried out in 1954.¹²

telescope with three counters. The angular resolution of the telescope was $\pm 1.5^\circ$. The detection limit of the protons was chosen to be $0.85 E_A \cos^2 \theta_2$ where E_A is the average energy of the protons in the beam A . With this energy choice charged particles from three processes were observed: diffraction scattering, quasi-elastic $p-p$ scattering and $p-n$ scattering without exchange and also production of mesons whose

energies were close to the maximum.

The results averaged from three independent series of measurements are given in Fig. 4. There, as in the remaining figures and tables, the given standard deviations are determined only by the statistics of the experiment. It is evident that the asymmetry of the angular distribution may be described by a smooth curve with a maximum at $\theta_2 = 9^\circ$.

TABLE I

Values of the asymmetry ϵ (18°) for various energy detection limits*

Thickness of copper absorber in cm	0	15	20
Energy detection limit in mev	30	435	530
ϵ (18°)	0.09 ± 0.01	0.11 ± 0.01	0.14 ± 0.02

At the angle $\theta_2 = 18^\circ$ the dependence of the asymmetry was measured as a function of the detection limit. The resulting data are shown in Table 1.

It was found that the asymmetry increases noticeably with the thickness of the absorber after 20 cm of Cu. With 23.5 cm thick Cu absorber the counting rate became vanishingly small. From the data of

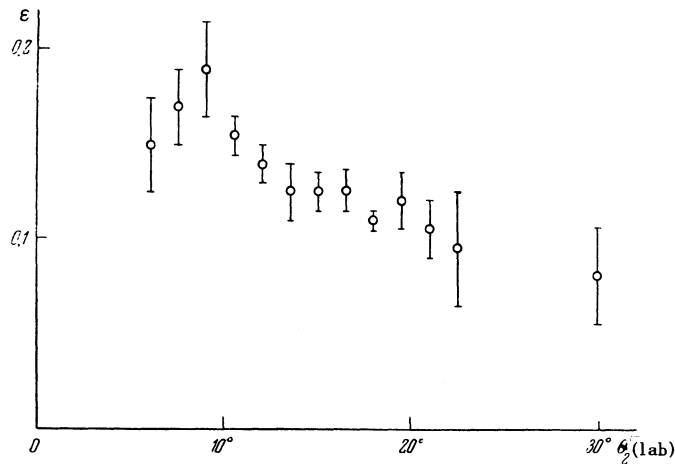

FIG. 4. Angular dependence of the asymmetry in scattering 565 mev protons from beryllium.

measurements on the spectra of charged π -mesons emitted in scattering of 660 mev protons from Be^{14} it is calculated that for energy of 565 mev and the total current of charged particles scattered at an angle of 18° and passed through the copper absorbers 20 cm thick, the contribution of the charged π -mesons did not exceed 2%. It did not exceed

*Observation of nuclear fission in photo-emulsions G5 placed in the beam A in the plane of the first scattering showed that there was an asymmetry in the forward scattering of charged particles equal to 0.11 ± 0.03 . The density of its tracks corresponded to proton energy of 200 mev. The asymmetry was not found exposing the plates in a plane perpendicular to the plane of the first scattering.

5% with a 15 cm thick absorber. On the basis of these calculations the asymmetry observed with copper absorbers 15–20 cm thick was interpreted as the asymmetry in the scattering of protons.

The increase in the asymmetry with an increase in the thickness of the absorber may be explained: a) by a small admixture of diffraction-scattered protons in the beam of the charged particles; b) by a smaller asymmetry in the nuclear cascade and processes generating π -mesons than for quasi-elastic $p-p$ scattering and $p-n$ scattering without exchange; c) by a variation in the behavior of the polarization in the spectrum of the quasi-elastically scattered protons. Since in a broad range of angles the polarization for the quasi-elastic scattering increases with a decrease in angle (cf. Sec. 7), it may be expected that in quasi-elastic scattering, protons scattered at given angles at energies greater than average energy will be somewhat more strongly polarized.

Neglecting the effect of the energy losses of protons and assuming that both in the first and in the second scattering of protons at an angle of 18° the major role is played by quasi-elastic $p-p$ scattering and by $p-n$ scattering without exchange, it is possible to obtain the polarization of the beam from the relationship $\epsilon = P_1(\theta_1) P_2(\theta_2)$, where $P_1(\theta_1)$ and $P_2(\theta_2)$ are the polarizations for the first and second scattering, respectively. For $\theta_1 = \theta_2$ and for the experimental data with 15 cm thick copper absorber, the polarization of the beam is $P_1(18^\circ) = \sqrt{\epsilon(18^\circ)} = 33 \pm 2\%$. From this value of $P_1(18^\circ)$ it follows that the magnitude of the asymmetry $\epsilon = 0.19 + 0.03$ at the maximum of the angular distribution; i.e., at $\theta_2 = 9^\circ$, it corresponds to the polarization of $60 \pm 10\%$. It is quite clear that an increase in the relative importance of the diffraction scattering among the observed processes is one of the major causes in the increase in the asymmetry with a decrease in the scattering angle.

5. POLARIZATION OF 635 MEV PROTONS

Two aligned telescopes adjusted for coincidence counts were used to determine the angular dependence of the asymmetry of the second scattered protons in beam B . The telescope closest to the beryllium analyzer was composed of three scintillation counters, and the one farther from the beryllium analyzer of two scintillation counters. The coincidence count in the first telescope and the coincidence count between the two telescopes were recorded simultaneously. A copper absorber

was placed between the two counters so that the detection limit of the first telescope was 230 mev while the detection limit of the system of the two telescopes varied with the scattering angle as $E_B \cos^2 \theta_2$ where $E_B = 635$ mev is the average proton energy in the beam B . Under these conditions, the quintuple coincidences were caused almost entirely by diffraction scattered protons and the effects caused by a variation in the proton energy in the profile of the beam were still negligible. By introducing delays into the electronic circuits, it was found that in the entire range of angles at which second scattered protons were observed, the number of accidental coincidences between the two telescopes did not exceed 1% of the total number of coincidences recorded with the analyzer in the beam. In the range of angles from $9^\circ - 50^\circ$, measurements were carried out with angular resolution of $\pm 2^\circ$. In the range of angles from $3-9^\circ$, where the effect of multiple scattering was still negligible, the measurements were made with angular resolution of $\pm 1^\circ$. The scattered protons were observed in solid angles of 2×10^{-3} and 6×10^{-4} steradian, respectively.

The results of the measurements of the angular dependence of the asymmetry are shown in Fig. 5. The white circles represent the values of asymmetry obtained from the quintuple coincidence counts; the black circles show the values of asymmetry calculated from the data obtained with the telescope closest to the analyzer. One observes that the asymmetry for the particles with a long path increases sharply with an increase in the scattering angle, reaches the maximum value of $.36 \pm .04$ at $\theta_2 = 7^\circ$ and then smoothly decreases up to 30° . The asymmetry of the total flux of fast charged particles is observed up to 42° , and is almost constant in the region of angles from 7° to 20° .

The data on the dependence of the asymmetry on the detection limit were obtained from measurements carried out with absorbers of various thicknesses placed between the two telescopes. The results of these measurements are given in Table II. The fact that for small scattering angles, the asymmetry turned out to be very much larger for particles with the maximum path, seems to be a definite proof of a greater polarization of diffraction scattered protons compared with particles emitted as a result of collisions with individual nucleons in the nucleus.

At the angle $\theta_2 = \theta_1 = 9^\circ$ the asymmetry is found to be 0.33 ± 0.03 from the data on quintuple coincidences. Therefore the polarization of

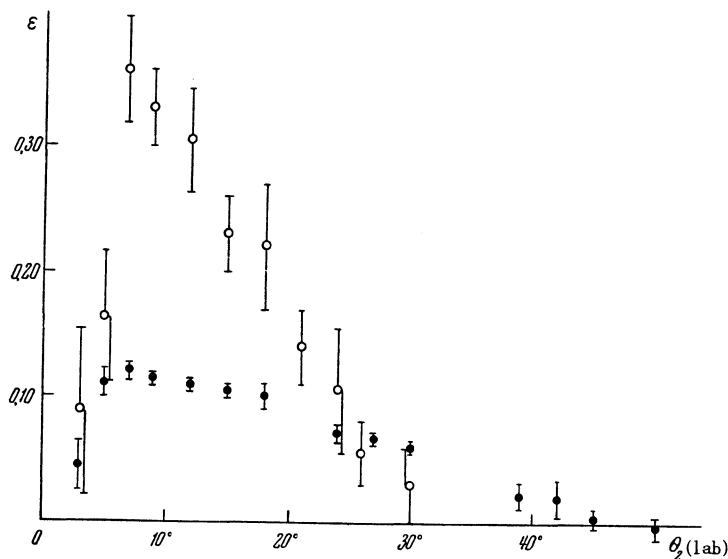

FIG. 5. Angular dependence of the asymmetry in scattering of 635 mev protons from beryllium: O—detection limit $E_{lim} = E_D \cos^2 \theta_2$, ● detection limit 230 mev.

protons in the beam B is $58 \pm 3\%$. To the maximum value of $\epsilon = 0.36 \pm 0.04$, observed at the angle of 7° , corresponds polarization of $62 \pm 10\%$. Indeed, the polarization of protons diffraction

TABLE II

The dependence of the asymmetry on the detection limit at 9° , 12° and 18°

Detection limit in mev	$\epsilon (9^\circ)$	$\epsilon (12^\circ)$	$\epsilon (18^\circ)$
160			0.06 ± 0.03
190			0.08 ± 0.03
230	0.11 ± 0.01	0.11 ± 0.01	0.10 ± 0.01
480			0.12 ± 0.02
565		0.17 ± 0.05	
580			0.23 ± 0.03
600	0.11 ± 0.04	0.16 ± 0.07	
610		0.31 ± 0.03	
620	0.33 ± 0.03		

scattered from beryllium is apparently even greater, since it was not possible to achieve a complete separation of the quasi-elastically scattered protons in these experiments. It should be noted that at the angle $\theta_2 = 9^\circ$, the contribution of the charged π -mesons to the number of quintuple coincidences did not exceed 1%.

Similar experiments on double scattering of protons from beryllium at lower energy are described in Refs. 4–6 and 15. The values of polarization of diffraction scattered protons corresponding

to the maximum values of the observed asymmetry given in these references are shown in Fig. 6. together with the results of the present experiments as a function of the energy of the first scattered protons. It is noteworthy to observe that the polarization of the diffraction scattered protons from beryllium does not change noticeably with an increase in the proton energy from 300 to 635 mev.

6. SCATTERING OF POLARIZED PROTONS FROM NUCLEI C, Al, Pb AND Bi

The measurements of asymmetry at $\theta_2 = 9^\circ$ for the above listed nuclei were carried out under the experimental conditions described in the previous section. The beryllium analyzer was replaced by a target made of carbon, aluminum, lead or bismuth equivalent in its stopping power to the beryllium target. The results of these measurements are given in Table III.

The values of asymmetry obtained at the detection limit of 620 mev were very similar for all of the investigated nuclei. At the 620 mev detection limit, the diffraction-scattering of protons was dominant while multiple scattering of protons from the analyzer did not play an important role as yet. The asymmetry in the scattering of charged particles of energy greater than 230 mev decreases imperceptibly with an increase in the dimension of the scattering nucleus. A discussion of the reasons why aluminum does not fit into this rule is better left until the time when additional data

on the angular dependence of the asymmetry of scattering of protons from this nucleus are available.

7. ASYMMETRY IN THE QUASI-ELASTIC $p-p$ SCATTERING AT 635 MEV*

The observation of the elementary processes in the quasi-elastic $p-p$ collisions was carried out by the technique of coupled telescopes described in Ref. 16. The scattered protons were detected in a solid angle of 1.7×10^{-3} steradian subtended by the surface of the first crystal nearest to the analyzer. The cross section of this crystal was 35×35 mm. The second and third crystals in this first telescope had cross sections of 45×45 mm and 50×50 mm. The detection limit of this telescope was 150 mev. The coupled telescope, consisting of crystals 52×52 mm and 60×60 mm in cross section, subtended a solid angle of 4.7×10^{-2} steradian. The coincidences between the telescopes were counted by circuits with a resolution

time of 5×10^{-8} sec. The angular resolution of the entire detection apparatus was about $\pm 2^\circ$. A beryllium disc 30 mm thick and 65 mm in diameter was used as an analyzer. The diameter of the beam at the location of the analyzer was 40 mm. In measurements of the asymmetry, the telescopes were located in the plane of the first scattering on both sides of the beam at angles θ_2 and θ_2' , related by the expression $\cot \theta_2 \cot \theta_2' = 1 + E/2Mc^2$, where E is the kinetic energy of the incident proton, Mc^2 is the proton rest energy. Experimental evidence was obtained to show that the contribution of the inelastic $p-p$ and $p-n$ collisions to the counting rate of the quasi-elastic $p-p$ scattering was negligible. The experiments carried out consisted of counting the coincidences between the two telescopes in the entire range of angles with the telescopes located relative to each other at angles not satisfying the above expression.

The values of asymmetry ϵ , obtained as a function of the scattering angle θ_2 in the laboratory

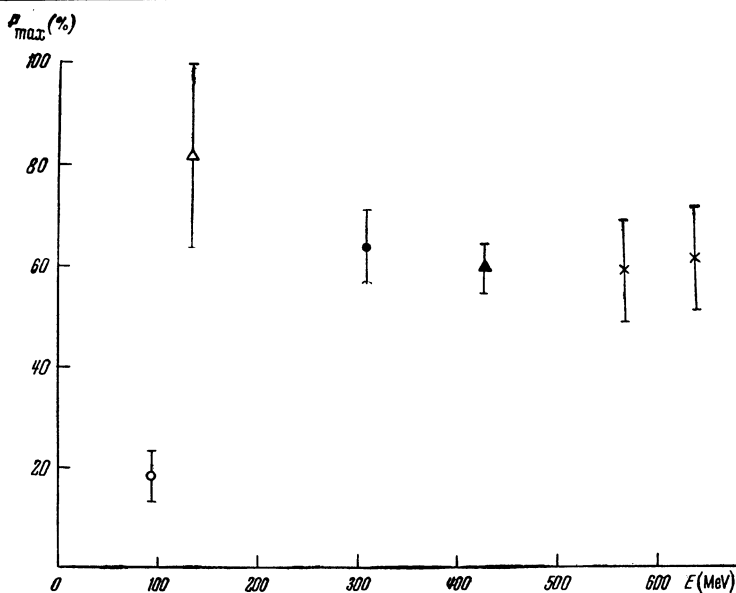

FIG. 6. Maximum value of the polarization of protons diffraction scattered from beryllium as a function of energy. The points are taken from the following references: O—Ref. 15; Δ —Ref. 6; \bullet —Ref. 4; \blacktriangle —Ref. 5; \times —this work.

system of coordinates, are given in Fig. 7. Taking the polarization of the first scattered beam to be $58 \pm 3\%$, one can find the polarization $P_{\langle pp \rangle}$

in quasi-elastic $p-p$ scattering from Be from the expression $\epsilon = 0.58 P_{\langle pp \rangle}$. At 40° in the center-of-mass system ($\theta_2 = 21^\circ$), the polarization $P_{\langle pp \rangle} = 35 \pm 4\%$,

In the present work, the asymmetry of free $p-p$ scattering was also measured at $\theta_2 = 21^\circ$.

*L. B. Parfenov has participated in the experiments described in this section.

Polyethylene and graphite scatterers, equivalent in the number of carbon nuclei, were used as

analyzers. The effect in hydrogen was determined by a differential method. It was found that the

TABLE III. The values of asymmetry for second scattered protons of 635 mev from Be, C, Al, Pb and Bi.

	Be	C	Al	Pb	Bi
ϵ ($E > 620$ mev)	0.33 ± 0.03	0.32 ± 0.04	0.25 ± 0.05	0.34 ± 0.07	0.30 ± 0.08
ϵ ($E > 230$ mev)	0.11 ± 0.01	0.13 ± 0.02	0.03 ± 0.01	0.08 ± 0.02	0.07 ± 0.02

asymmetry is equal to 0.25 ± 0.07 with corresponding polarization $P = 43 \pm 4\%$. It is evident that for 635 mev protons, the polarization in quasi-elastic p - p scattering is only slightly smaller than the polarization in the free p - p scattering.

Similar measurements of the asymmetry in quasi-elastic p - p scattering from Be were carried out for 285 mev protons by Donaldson and Bradner.¹⁷ From their data, the polarization at 40° in the center-of-mass system for quasi-elastic p - p scat-

tering is $P_{<pp>} = 15 \pm 4\%$, while the polarization for free p - p scattering under the same conditions is $\sim 42\%$.²

A comparison of the experimental data given above shows that with an increase in the proton energy from 285 to 635 mev: 1. the difference in the degree of polarization between quasi-elastic and free elastic p - p scattering disappears, 2. polarization in the free p - p scattering does not change noticeably.

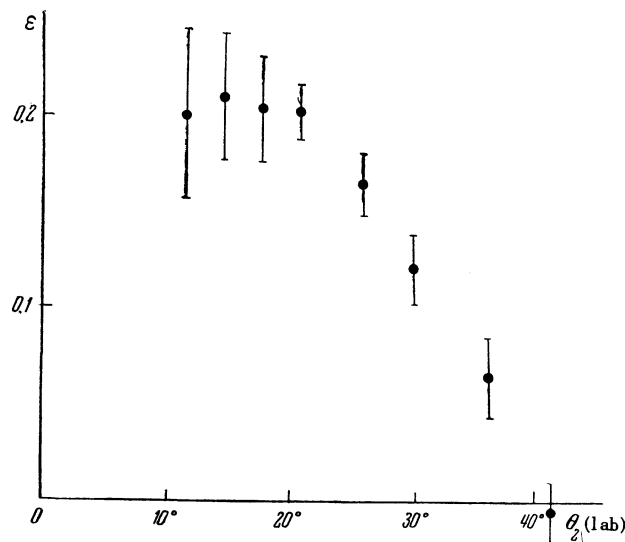

FIG. 7. Angular dependence of the asymmetry in quasi-elastic p - p scattering in beryllium at 635 mev.

8. CONCLUSIONS

From the experimental results described above, one can form the following conclusions:

1. At 660 mev the polarization of protons is due to both diffraction-scattering and quasi-elastic scattering. In both polarization processes, the spin has the same orientation as in

the free p - p scattering.

2. The values of the asymmetry, obtained at the angle 9° in scattering of polarized protons with energy greater than 620 mev from Be, C, Al, Pb and Bi nuclei, were the same within the experimental error.

3. A comparison of the data currently available for double scattering of protons from beryllium

shows that:

a. The maximum value of the polarization of the diffraction-scattered protons does not change noticeably with an increase in energy from 300 to 635 mev and is not less than 60% at 635 mev.

b. The polarization of protons in quasi-elastic p - p scattering increases by more than a factor of two with an increase in the proton energy from 285 to 635 mev. It reaches values only slightly smaller than the polarization for free p - p scattering.

4. One may suspect that the polarization of protons in free p - p scattering has the same value at 300 mev as at 635 mev. However, the data obtained in this work are very sparse.

The authors express their gratitude to R. M. Ryndin for his participation in the evaluation of the experimental results and to Iu. K. Akimov and A. S. Kuznetsov for their help in the construction of the electronic apparatus.

¹Oxley, Cartwright and Rouvina, Phys. Rev. 93, 806 (1954).

²Chamberlain, Segre, Tripp Wiegand and Ypsilantis, Phys. Rev. 93, 1430 (1954).

³Marshall, Marshall and de Carvalho, Phys. Rev. 93, 1431 (1954).

⁴de Carvalho, Marshall and Marshall, Phys. Rev. 96, 1081 (1954).

⁵Heiberg, Kruse, Marshall, Marshall and Solmitz, Phys. Rev. 97, 250 (1955).

⁶Dickson, Rose and Salter, Proc. Phys. Soc. (London) A68, 361 (1955).

⁷E. Fermi, Nuovo Cim. 11, 407 (1954).

⁸Snow, Sternheimer and Yang, Phys. Rev. 94, 1073 (1954).

⁹B. Malenka, Phys. Rev. 95, 522 (1954).

¹⁰W. Heckrotte and J. V. Lepore, Phys. Rev. 95, 1109 (1954).

¹¹Meshcheriakov, Shabudin, Zrelov, Neganov, Vzorov, Azhgirei, Proc. Inst. Nucl. Probl. (1956).

¹²L. D. Stoletov and S. B. Nurusev, Proc. Inst. Nucl. Probl. (1954).

¹³E. L. Grigorev, J. Exptl. Theoret. Phys. (U.S.S.R.) 28, 761 (1955); Soviet Phys. JETP 1, 608 (1955).

¹⁴Meshcheriakov, Vzorov, Zrelov, Neganov, and Shabudin, J. Exptl. Theoret. Phys. (U.S.S.R.) 31, 55 (1956).

¹⁵K. Strauch, Phys. Rev. 99, 150 (1955).

¹⁶Meshcheriakov, Bogachev, Neganov and Piskarev, Dokl. Akad. Nauk SSSR 99, 955 (1954).

¹⁷R. Donaldson, and H. Bradner, Phys. Rev. 99, 892 (1955).

Translated by M. J. Stevenson