

On the Mass Spectrum of Charged Cosmic Ray Particles

A. I. ALIKHANIAN, N. V. SHOSTAKOVICH*, A. T. DADAIAN,
V. N. FEDOROV AND B. N. DERIAGIN

*P. N. Lebedev Physical Institute, Academy of Sciences, USSR
Physical Institute, Academy of Sciences, Armenian SSR*

(Submitted to JETP editor July 21, 1956)

J. Exptl. Theoret. Phys. (U.S.S.R.) 31, 955-970 (December, 1956)

Results of an investigation of the cosmic ray particles mass spectrum at 3200 m are reported. The measurements were carried out by means of a magnetic spectrometer used in conjunction with two cloud chambers. Protons, deuterons, π -mesons and K -particles were observed among the particles locally generated in stars above the experimental arrangement.

The cases of 11 particles with masses of about 500-600 m_e stopping in the lower chamber are discussed. In all these events, neither a star nor a shower was observed in the upper chamber. It was found that some of these particles entered the apparatus from the outside in a similar manner to the μ -mesons.

1. INTRODUCTION

SYSTEMATIC measurements of the momentum and range of charged cosmic ray particles, dating from 1946, have led us to conclude that unstable particles heavier than the μ -meson exist. Under the assumption that the particles were stopped as a result of ionization losses, it was impossible to explain the experimental data obtained by us by postulating the existence of only one new particle heavier than the μ -meson. It was necessary to assume the existence of three groups of particles with masses intermediate between those of the μ -meson and of the proton, namely of particles with masses equal to 350, 500-600 and 950 electron masses.¹

Having increased the resolving power of the magnetic spectrometer, we were later able to resolve spectrally the π -mesons and the μ -mesons. The groups of particles with masses 580 and 950 m_e , well resolved from π -mesons and protons, were again found in the mass spectrum, obtained from range and momentum measurements.^{2,3} Since the observed particles traversed a path longer than one meter, we concluded that the mean life of the particles of all three groups should be longer than 5×10^{-9} sec.

The mass determination from range and momentum measurements can sometimes be in error, since the π -mesons present in the beam of particles can be stopped in absorbers for any value of momentum, and in this way imitate particles of larger mass. In using this method of mass determination it is therefore necessary to have proof that the particle was stopped due to ionization losses. Alikhanian and Kharitonov^{4,5} added proportional counters to the magnetic spectrometer and determined the specific ionization of the particles of intermediate masses,

together with their range and momentum. It was shown that the majority of particles of the 950 m_e group possess a larger specific ionization, and only a part is due to relativistic π -mesons stopping in absorbers as the result of nuclear collisions. These measurements made it possible to establish the existence of mesons with mass $\sim 1000 m_e$.

The observations of many authors, using an extended set-up containing cloud chambers, later confirmed our conclusions as to the relatively long life time of charged particles with mass equal to $\sim 1000 m_e$ (K -particles).

The existence of charged particles with mass equal to 500-600 m_e has until recently been uncertain. Several authors expressed doubt as to their existence. A few trajectories of particles with mass 500 m_e were observed in experiments of Daniel and others^{6,7} without any further confirmation.

In 1952, we carried out a series of observations of heavy particles stopping in a multiple-plate cloud chamber, used in conjunction with a magnetic spectrometer. This set up made it possible to determine, for each particle, whether the stopping was due to ionization losses and, the momentum being known, to find its mass. In the course of a prolonged series of measurements carried out by means of the above set up, we found 32 particles, stopping in the multiple-plate chamber, the masses of which, determined from the momentum and the ionization range, were between 460 and 1100 m_e .

In this series of measurements, another large rectangular cloud chamber containing lead plates was placed above the magnetic spectrometer. Studying (in the upper chamber) the trajectories of the particles which traverse the magnetic spectrometer and are stopped in the lower chamber, it was possible in many instances to determine the mechanism and the place of creation of particles with

*Deceased.

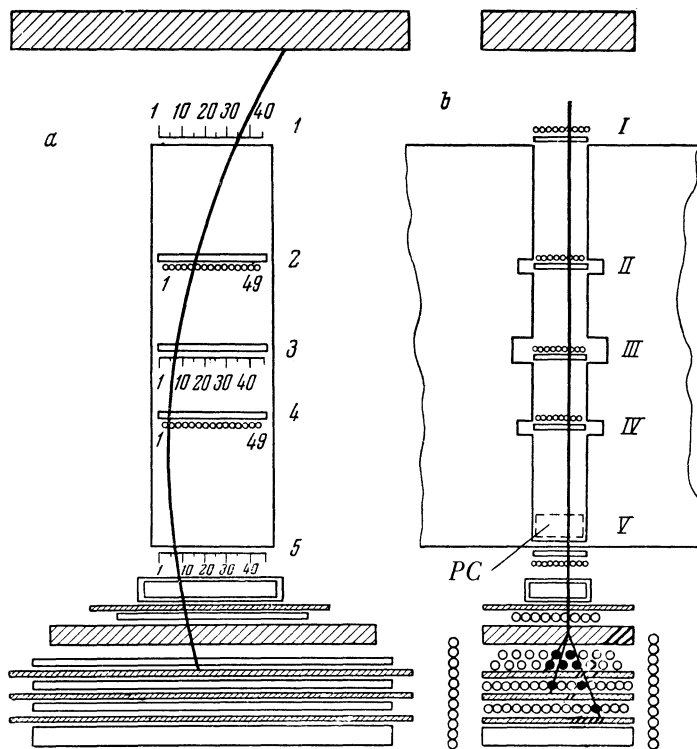

FIG. 1. Schematic diagram of the magnetic spectrometer with a proportional counter and the arrangement of absorbers. PC—proportional counter 1.

different masses. In the majority of cases a star could be found in the upper chamber, from which the π - and K -mesons originated. Not in a single case of stopping particles with the mass 500–600 m_e was it possible to observe a star, or a shower, in the upper chamber.

2. RANGE-MOMENTUM MEASUREMENTS OF THE MASS SPECTRUM

In this Section, we present a brief summary of the basic results of the particle mass measurements carried out in 1950–1952 by means of the magnetic spectrometer. The mass of the particle was determined from the momentum and the amount of matter traversed by the particle in the filter arrangement. Two rectangular proportional counters were placed in the particle trajectory, at the exit from the magnetic spectrometer. This made it possible to determine the specific ionization of the particle.

The magnetic spectrometer of high resolving power, which was placed at 3200 m above sea level², is shown in Fig. 1. A large electromagnet weighing 76 tons forms the main part of this instrument. The pole pieces are 100 cm long and 30 cm wide, the distance between them being equal to 12 cm. The maximum field strength in the gap of

this electromagnet can attain 1900 Oe. The cross sections of the instrument in two perpendicular planes are shown in Fig. 1. Five trays of thin-walled counters 4.6 mm in diameter are placed in the gap (1–5, view *a*), which make it possible to determine five points of the circular trajectory of the particle. A tray consists of 49 hodoscoped counters.

The counters in trays 2, 3 and 4 are constructed of aluminum tubes, with walls about 100 μ thick, to minimize scattering. Five trays of coordinating thin-walled counters (I–V) make it possible to determine simultaneously the straight-line trajectory in the plane parallel to the magnetic field (view *b*). The particle leaving the magnet gap enters the absorber arrangement, consisting of five trays of coordinating counters, separated by graphite slabs 2 or 4 cm thick each.

The accuracy of the mass measurements in the magnetic spectrometer is limited basically by the following three factors: 1) the finite dimensions of counters, 2) scattering in counter walls, and 3) errors in the range determination. For the case of particles stopping only as a result of ionization losses, the errors in the value of the range are caused by the finite thickness of filters. It follows from a calculation that, in a field of 6400 Oe, the

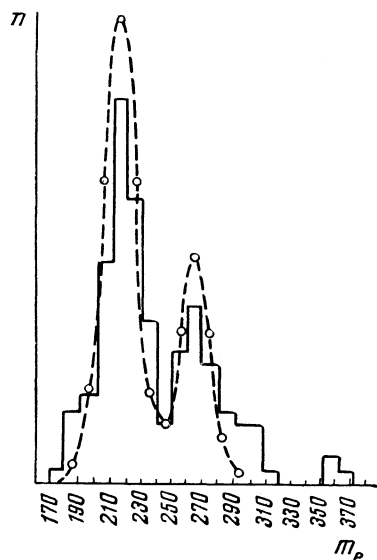

FIG. 2. Mass spectrum of negative particles in the 180–400 m_e interval (without aperture correction)

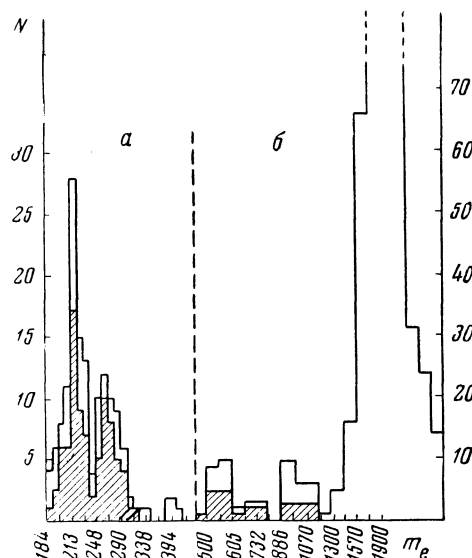

FIG. 3. Mass spectrum (without aperture correction): a) at 6400 Oe, $24 > R > 16$ cm C; b) at 6400, 9200, and 10500 Oe, $24 > R > 12$ cm C.

half width of the μ -meson line amounts to $16 m_e$, thus enabling a good resolving of the π - and μ -mesons. The mass spectrum of negative particles in the interval 180–400 m_e is shown in Fig. 2. In these measurements, a lead block 10 cm thick was placed under the set up. It can be seen in Fig. 2 that the μ -meson group shows up distinctly, next to the π -meson group. The broken curve represents the Gaussian distribution curve, calculated for a probable error of $16 m_e$, which closely fits the observed distribution. This result is a good illustration of the resolving power of the magnetic mass-spectrometer.

In the course of these measurements in 1950–1951, we obtained the mass spectrum in the total interval between the μ -meson and the proton.^{8,9} This spectrum is shown in Fig. 3. Two groups of heavy mesons, concentrated around the values 600 m_e and 1000 m_e , are visible in the mass spectrum.

It followed from the complete data that a considerable part of the particles of masses 600 and 1000 m_e was stopped in the absorbers as the result of ionization energy losses. 1) A sharp grouping of the particles around two mass values was observed, which would have been impossible if the particles were stopped in the absorbers as the result of nuclear collisions. 2) The mean values of the momentum of the particles with intermediate mass values increase with the range of the particles. The average momentum of particles with a range of 4–12 cm in graphite was found to be equal to 2.9×10^8 ev/c, and that of particles with a range

of 12–16 and 16–24 cm in graphite to 3.12 and 3.61×10^8 ev/c, respectively. A systematic increase of the average momentum with the range can take place only as the result of ionization stopping. 3) The measurements of the specific ionization of particles, carried out in 1951 by means of proportional counters placed in the magnetic spectrometer, showed that the value of the specific ionizations for the intermediate particles is larger than the minimum ionization by a factor of 1.5–2.

The measurements of the specific ionization of particles in 1951 were carried out by means of two proportional counters, the position of which is shown in Fig. 1. It was necessary to calibrate the pulses given by each counter in order to obtain the relative specific ionization of different particles. Penetrating particles with a range larger than 14 cm were used for this purpose. The pulse size distribution, obtained with the counter No. 2 shown in Fig. 4, is based on data obtained from 14829 penetrating particles, the momentum of which was determined from the curvature in the magnetic field (curve 2). Curve 1 in this figure represents the theoretical curve of energy loss fluctuations in the counter gas according to the theory of Landau.⁹

Alikhanian and Kharitonov⁵ measured the specific ionization of 87 particles which, from the values of their range and momentum, were classified as particles of intermediate mass. From the total of 87 particles, data were obtained simultaneously, by means of the two counters 1 and 2, for 26 particles only. For all remaining particles, the ionization was determined by means of counter 2 only. The

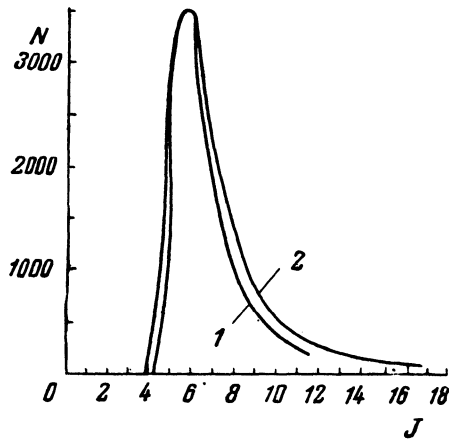

FIG. 4. Distribution of minimum ionization particles. N —number of particles, J —relative ionization.

results of these measurements are given in Ref. 10. It was shown that the specific ionization of heavy mesons is considerably larger than that of μ -mesons of the same values of momentum ($2.8 - 4.5 \times 10^8$ ev/c). Besides, it is much smaller than the specific ionization of protons having the same range. Distribution curves of the specific ionization were plotted for heavy mesons and protons. In the case of protons, the proportion of cases when the ionization was twice the most probable one was equal to $14 \pm 3.5\%$, while for heavy mesons (of both groups) it amounted to $12 \pm 4\%$. It follows that the increased specific ionization of these particles cannot result from a mixture of a separate group of strongly ionizing particles with particles of minimum ionization. Consequently, the heavy mesons observed by us in the mass spectrum could not have appeared only as a result of nuclear stopping of fast π -mesons.

The data on the specific ionization of the intermediate mass particles were used for an independent determination of the mass of the particles from their momenta and ionization. For this, we used a method suggested by Liubimov.¹¹ Let a particle with momentum P produce an ionization J in the counter. We shall assume that the mass of the particle equals m . Then, knowing the ratio P/m , it is possible, according to the Landau formula, to find the most probable value J_0 of the specific ionization of the particle, and then, from the experimental curve of the ionization fluctuation, to find the probability that the actual ionization will equal J , and not J_0 . We can repeat this procedure for all particles of a given group, and the product of the found probabilities will give us the probability of observation of a given set of the ionization values J , under the assumption that all particles of the group have the mass m and the observed values of momentum.

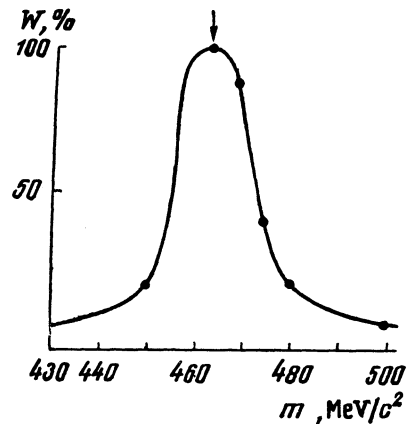

FIG. 5. Probability curve of various mass values in the interval $800-1100 m_e$.

Assuming another value of the mass m_1 , we shall obtain a new value of the probability of observation of a given set of the experimental values of the ionization J , produced by the particles in the working volume of the proportional counter. The sequence of such probabilities, determined for the various values of the particle mass m , and correspondingly normalized, can be regarded as the probabilities of the various values of the mass of the particles, for given sets of observed values of ionization and momentum. The maximum of the curve probability vs. mass will correspond to the most probable value of the mass of the investigated group of particles.

The above procedure was applied to a group of 48 particles, the mass of which, derived from the range and momentum measurements, was found to be between 800 and $1100 m_e$. The resulting curve of the probability of the various values of the mass of the particle for the obtained set of experimental values of momentum and ionization is shown in Fig. 5. The curve has a sharp maximum, corresponding to the mass equal to 4.65×10^8 ev/c,² i.e., 910 electron masses. For the values of mass, different from the most probable one by only 10% , the probability curve drops rapidly to zero.

For the sake of comparison, 50 proton trajectories with ranges varying from 4.5 to 5.0 cm were given the same treatment. The results are shown in Fig. 6. The most probable value of the proton mass obtained was equal to 935.5 ev/c², i.e., $1830 m_e$ with a probable error of $\pm 20 m_e$. We tried to apply the same method of evaluation of the momentum and ionization measurements in the case of particles with mass $500-600 m_e$. In this case however, the specific ionization of the particles does not exceed the minimum ionization to any extent and

the results are therefore less satisfactory than in the case of K -particles and protons.

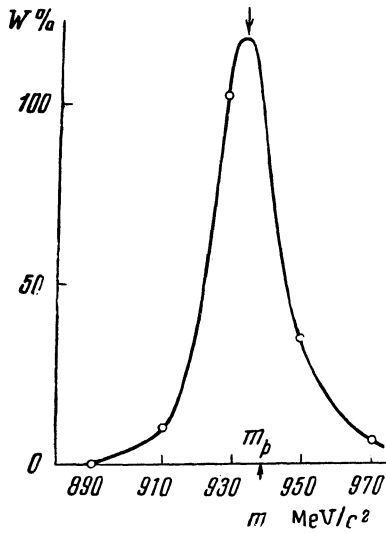

FIG. 6. Probability curve for protons with range between 4.5 and 5.0 cm Pb.

3. MEASUREMENTS OF THE MASS OF THE COSMIC-RAY PARTICLES WITH THE MAGNETIC SPECTROMETER AND A MULTIPLE-PLATE CLOUD CHAMBER

In this Section, we shall report results of observation of charged particles stopping in a multiple plate cloud chamber, used in conjunction with the magnetic spectrometer. This set-up was first used in 1952 by Alikhanian, Kitillov-Ugrimov, Shostakovich and Fedorov at 3250 m altitude (Alagez). Description of the apparatus and details of results can be found in Refs. 12, 13 and 14. A schematic drawing of the apparatus in two perpendicular projections is shown in Fig. 7. A rectangular cloud chamber, containing lead or copper plates of various thicknesses, was placed under the magnetic spectrometer. A tray of counters A , connected to an anti-coincidence circuit, was placed below the bottom of the chamber. The set-up was triggered when a particle, traversing the magnetic spectrometer, discharged counters in trays 2, 4 and 5 and failed to discharge a counter in the tray A (series 1). The rectangular cloud chamber $400 \times 250 \times 120$ mm contained in the illuminated space seven filters: one filter consisting of a lead plate 10 mm thick and a copper plate 3 mm thick, and 6 copper plates each 3 mm thick.

In the second series of measurements, the trigger was given by the anti-coincidence 1,3,5- A and a larger chamber, $600 \times 280 \times 180$ mm was used. In this series, seven lead filters, each 7 mm thick,

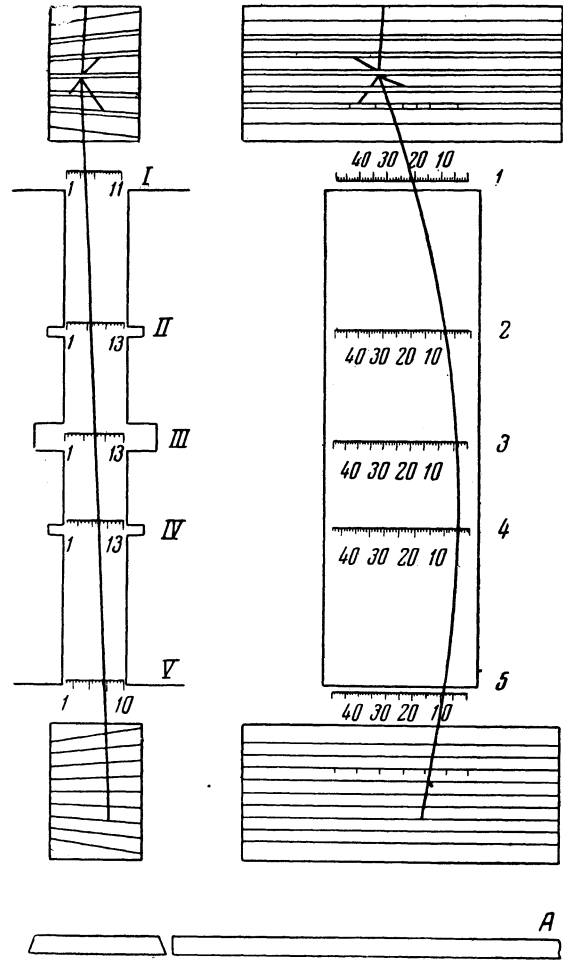

FIG. 7. Schematic diagram of the magnetic spectrometer with two cloud chambers.

were placed in the illuminated space. Some of the measurements of the second series were carried out with filters placed in the lower chamber in the following order: the first two lead plates were 7 mm thick each; the following three plates were each 4 mm thick, and the sixth lead plate was of 7 mm thickness. The seventh plate was a copper one, 2 mm in thickness.

A charged particle, before entering the visible space, passed through the top of the chamber, consisting of an aluminum plate 7 mm thick and a copper plate 2 mm thick (a total of 3.7 gm/cm^2). The chamber was illuminated by two pulsed quartz lamps 1PK-600. The tracks in the chamber were photographed with a stereoscopic camera on motion-picture film.

In the second series of measurements, a second cloud chamber, of the same dimensions as the lower one, was placed above the spectrometer instead of

the lead block (see Fig. 7). In the illuminated region of the upper chamber, the top and the bottom were 1.2 cm thick (copper) and five lead plates, each 1 cm thick, were placed in the chamber. In this way it was possible to observe the trajectory of the particle before it entered the magnetic spectrometer and stopped in the lower chamber. If the particle recorded by the apparatus left the illuminated region of the upper chamber, either a star in which it originated could be observed, or it could be decided that the particle came from the outside. The efficiency of observation of particles in the upper chamber, which then were recorded in the lower chamber, depends essentially on their momentum. The efficiency is large for protons and heavy mesons, and is very small for slow μ^- and π^- mesons, the majority of which emerge from the sectional parts of the upper chamber, and in the beginning pass through non-illuminated zones.

4. SELECTION OF TRAJECTORIES, ACCURACY OF MASS MEASUREMENTS, APERTURE.

Range and momentum measurements of a large number of particles stopping in the lower chamber were carried out by means of the apparatus described.

The mass spectrum of particles, which is given below, was derived from trajectories fulfilling the following conditions: a) in the plane of magnetic deviation the trajectories of the particles were determined from at least four points, lying on a circle; b) in the perpendicular plane, the trajectories passed through at least three points lying on a straight line; c) the track of the particle entering the lower cloud chamber was a continuation of the trajectory of the particle in the magnetic spectrometer; the only deviations allowed were in the limits of the angle of multiple scattering in the cover of the chamber; d) the particle stopped in the illuminated region of the lower chamber, the limits of which were determined by special measurements.

From all trajectories fulfilling the above conditions, only those were included in the mass spectrum whose stopping was due to ionization, i.e., when a considerable increase in the track density was observed with decreasing residual range. In the majority of cases, the track density was estimated visually and compared with that of relativistic particles traversing the same region of the chamber. In some of the more interesting cases, the track density was determined from microphotometric measurements. Track density of mesons, protons and minimum ionization particles traversing the same chamber region and photographed on the same film were used as a check.

The method of microphotometric density determination is not accurate enough to measure the specific ionization of particles, and serves only as auxiliary means of objective estimate of the value of ionization and its variation. The sensitivity and accuracy of this method are sufficient, in the majority of cases, to distinguish a sudden stopping of a fast particle from a stopping due to ionization, when a gradual increase in the track density is observed.

One of the cases of a particle stopping in the sixth plate is shown in Fig. 8. The increase of the track density can easily be observed. The same can be deduced from the microphotogram of this case, shown in Fig. 9. The track of a π^- meson with momentum 4.0×10^8 ev/c, undergoing a nuclear collision in the fifth plate and producing a two-prong star, is shown in Fig. 10. In this case, the track density remains practically the same along the whole trajectory, which, within the limits of possible fluctuations, is observed in the microphotogram as well (Fig. 11). The range of a particle, the ionization character of the stopping of which was established, was determined from the quantity of traversed matter, the slope of the trajectory being accounted for.

The main source of error of the mass determination is the error of the momentum measurement. For the case of slow particles, these errors are mainly caused by scattering in counter walls and, in part, by the finite dimensions of counters. Experiments on scattering of cosmic ray particles within the telescope of the mass-spectrometer, with magnetic field absent, showed that for penetrating particles, the mean square value of the false curvature is not larger than 0.016 m.^{-1} . For slow particles, stopping in the lower chamber (μ^- mesons and protons with ranges from 0.55 to 2.55 cm Pb), the mean square value of the false curvature equalled 0.045 m.^{-1} . The experimental scattering curves, obtained in experiments without the magnetic field, confirmed the correctness of the calculated errors of momentum measurements, in which both the multiple scattering in the walls of the counters and their finite dimensions were taken into account.¹⁵

In magnetic field of 4800 gauss, in which the measurements were carried out, the total mean square error of the mass determination of an individual particle amounted to 9–10% for particles with mass $1000 m_e$ and 8% for particles with mass $500 m_e$. The error due to the finite size of the counter is not larger than 2–2.5%. The efficiency of particle recording in a magnetic spectrometer (the aperture) decreases with decreasing value

5. MASS SPECTRUM

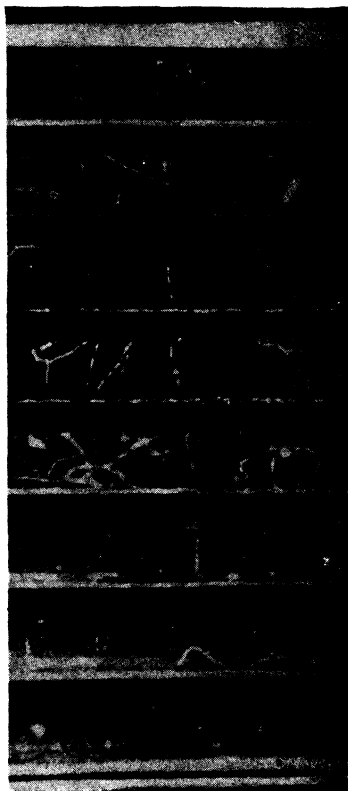

FIG. 8. Stopping of a negative particle. Mass equal to $500 m_e$ (range-momentum method).

of the momentum of the particle. We calculated the curves of the efficiency of recording of particles of different momenta under the assumption of an isotropic angular distribution of incident particles. With the help of these curves, and taking into account the limits of the illuminated region in the lower chamber and the place of the end of the range of the particle, we constructed a family of curves of the recording efficiency of particles of different momenta, stopping in the illuminated region of the chamber.

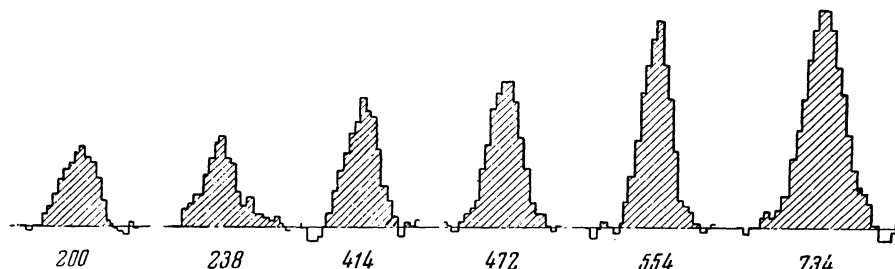

FIG. 9. Microphotogram of the particle track shown in Fig. 8. The numbers express the relative track density.

The mass spectrum of particles stopping in the plates of the lower chamber, is shown in Fig. 12. The spectrum is based on the trajectories of particles, selected according to conditions mentioned in Sec. 4. A group of 21 K -particles and of particles with masses between 500 and $600 m_e$ can be seen in the spectrum next to the main peaks due to mesons (μ and π) and protons. The accuracy of the mass measurement of a single K -particle lies, for the majority of cases, within the limits of 80 – $100 m_e$, and of a proton, within 180 – $200 m_e$, thus ensuring the spectral resolution of K -particles from the large proton peak.

Fifteen of the 17 K -particles recorded in the second series of measurements were positive and only two were negative. One of the cases in which a positive K -particle stops and decays is shown in Fig. 13. A primary particle with momentum $p = 3.25 \times 10^8$ ev/c is stopped in the fourth plate, so that the total amount of matter traversed after the particle has left the magnetic field equals 2.53 cm Pb. The mass, determined from therange and momentum, equals $910 \pm 75 m_e$. A fast meson which leaves the chamber after traversing 21.5 g/cm² Pb emerges from the end point of the track of the K^+ particle.

Fast decay products were observed in about half of the cases of stopping K^+ particles. In a number of cases, the absence of decay products can be connected with absorption of these in the lead plate (τ -decay or K -decay). In other cases, the absence of a visible decay product can be explained by an unfortunate direction of flight of the secondary particle. The frequency of observation of K -particles, as compared with π -mesons and protons in the same range interval, can be found from the spectrum in Fig. 12 after a correction is made for different recording efficiencies of particles with various momenta. This correction was determined approximately, on the basis of the isotropic angular distribution of the particles under

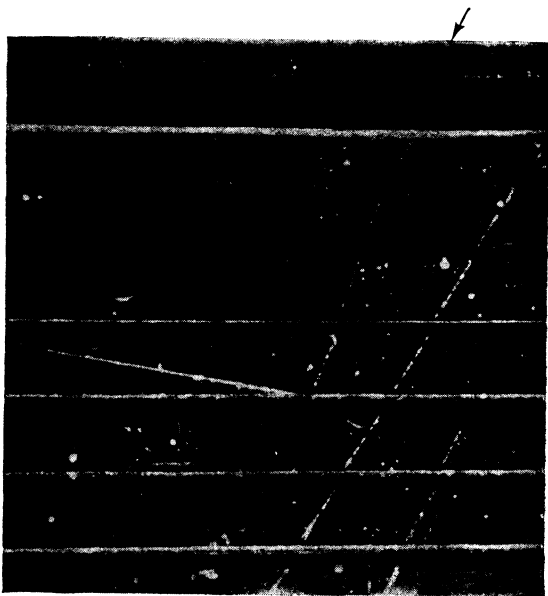

FIG. 10. Sudden stopping of a π -meson of momentum 4×10^8 ev/c accompanied by a production of a star.

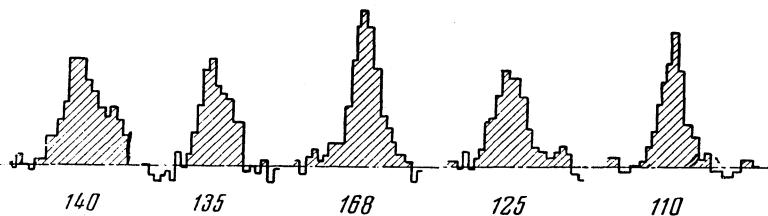

FIG. 11. Microphotogram of the track of the fast π -meson shown in Fig. 10.

the non-illuminated part. Eleven out of eighteen π -mesons with momenta in the range of $2-4.5 \times 10^8$ ev/c stopping suddenly in the absorbers of the lower chamber were accompanied by stars in the illuminated part of the upper chamber (Table II).

The spectrum shown in Fig. 14, is based on particles which originated in stars, all the particles whose origin in the upper chamber is uncertain being excluded. It is found that the mass spectrum of particles locally produced in stars differs basically from the total spectrum. π -mesons, K -particles, protons and deuterons are present in the spectrum of the star-born particles, while particles with the mass $500-600 m_e$ are completely absent. Evidently the latter type of particles either does not originate in stars at all, or at least the frequency of such events is considerably lower than is the case for K -particles. The spectrum in Fig. 14 is not

consideration. The data given in Table I show that in the same range interval, $20K^+$ particles are observed, as compared with 240π -mesons stopping as the result of ionization losses, which amounts to about $(8 \pm 2)\%$.

In the same period of observation, 9 fast π -mesons stopping in absorbers as the result of nuclear interactions were recorded. The mass values of these mesons, determined formally from their range and momentum, were found to lie in the limits $800-1200 m_e$. The thin tracks of fast π -mesons, imitating heavy mesons, could easily be distinguished from stopping K -particles, for which the track density increases sharply towards the end of the track. Studying the trajectories in the upper chamber it was possible to ascertain that the K -particles and π -mesons originated in stars produced in the matter present in the upper chamber, or emerged from non-illuminated zones. Fast π -mesons and K -particles with values of momentum equal to $2.5-4.5 \times 10^8$ ev/c could be sufficiently well studied in the upper chamber. Thus, for instance, of seventeen K -particles recorded in the lower chamber, thirteen originated in stars occurring in the illuminated part of the chamber, and only four in

corrected for the efficiency of recording of particles with different values of momentum, which depends, basically, on the dimensions of the illuminated parts of the upper and lower chambers.

Data on particles whose mass, as measured by the range-momentum method, was found to be intermediate between the masses of the π -meson and of the K -particle, are given in Table III. Eleven such particles were recorded in the course of the second series of measurements, which was the most prolonged, and one was recorded in the first series.

It can be seen from the Table that the mean square error of the mass measurement of a single particle does not exceed $40-50 m_e$. The grouping of particles around the mass value $550 m_e$ serves as a serious proof of the existence of particles with this mass.

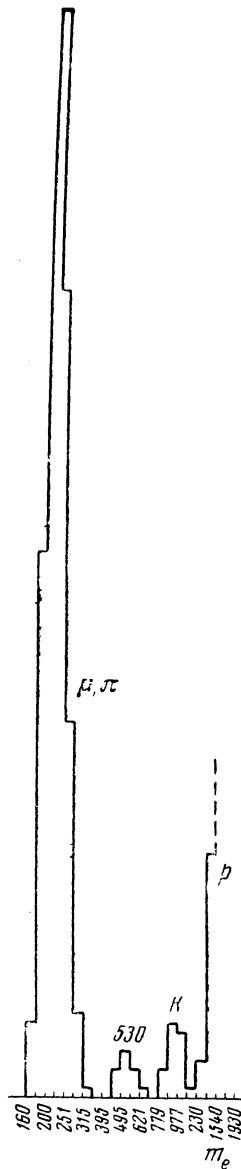

FIG. 12. Total mass spectrum of particles stopping in the lower chamber as the result of ionization loss (without aperture correction)

The results of the tracing of the trajectories of these particles in the upper chamber are given in the last column of Table III. The cases when the particle entered the chamber from above or originated in the thin cover of the chamber are marked by an arrow. In the case where the particle emerged from a dark region of the chamber, its origin was classified as not established. It should be noted that the apparatus was so situated within the building that the amount of matter above the upper chamber was small. This amount was 2gm/cm^2 of wood for two-thirds of the solid angle used, and not more than 10gm/cm^2 for the remaining part of it.

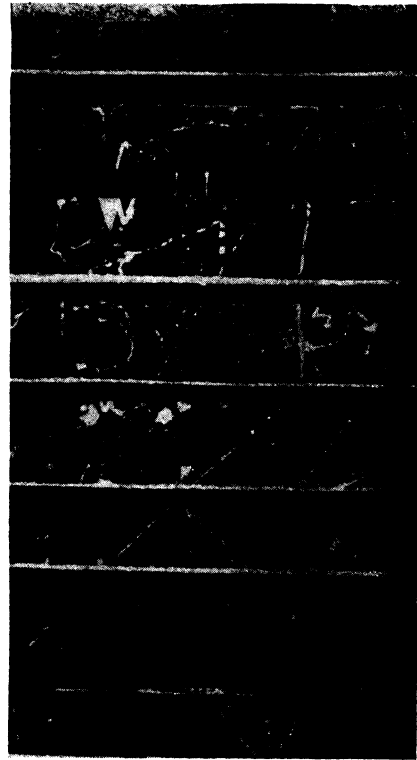

FIG. 13. Stopping and decay of a K^+ -particle in the fourth plate.

TABLE I

Range, cm Pb	2-5
Number of π -mesons, n_π	71
Number of π -mesons with aperture correction, N_π	240
Number of K -particles, n_K	15
Number of K -particles with aperture correction, N_K	20
N_K/N_π	0.08 ± 0.02

The detailed analysis has shown that four out of six particles which definitely entered the chamber through the thin cover traversed the thin layer of 2gm/cm^2 only. Also, no case of production of particles with mass $500-600 m_e$ was observed in the plates of the upper chamber containing about 65gm/cm^2 of matter.

In the majority of cases, stopping particles of the $500-600 m_e$ group were not accompanied by fast secondary particles (decay products). It should be noted that nine out of the eleven particles of this group were of negative sign. It may be possible that this fact made it impossible to detect

TABLE II

Momentum $P \times 10^8$ ev/c	Sign	Range, cm Pb	False mass M	Product	Upper chamber observation
2.09	—	3.04	430 m_e	↓	*
2.57	+	3.52	520	*	*
2.06	—	2.32	450	↓	*
2.57	—	2.95	585	*	Non-illuminated region
2.25	+	1.64	640	*	The same
2.77	+	2.50	720	*	"
2.23	+	2.20	560	*	"
2.96	+	2.72	750	↓	Camera did not operate
3.50	+	2.30	1070	*	*
2.92	—	1.60	970	↓	*
4.00	+	3.83	1000	↓	↓
2.70	++	1.58	860	*	*
3.65	+	4.00	840	*	*
3.42	—	1.55	1200	*	*
4.43	—	4.40	1080	*	*
3.85	—	3.85	1085	*	Non-illuminated region
4.50	—	4.65	1050	↓	The same
3.00	—	3.00	730	*	*

Explanation of signs: *—star; ↓ —stopping of a π -meson without visible star;
↓ —particle incident upon the upper chamber from above.

TABLE III

No. of case	Momentum $P \times 10^8$ ev/c	Sign	Range, cm Pb	Mass m_e	Product	Upper chamber observation
1	2.02	—	2.40	460 ± 40	absent	
2	2.66	—	4.35	505 ± 35	"	Non-illuminated region
3	2.70	—	3.52	590 ± 40	"	Camera did not operate
4	2.35	—	3.90	445 ± 45	"	↓
5	3.00	+	5.35	550 ± 60	$e?$	↓
6	2.84	—	3.65	610 ± 55	absent	Non-illuminated region
7	3.14	—	4.80	600 ± 60	"	Part of the track in the non-illuminated region
8	2.33	—	3.15	495 ± 40	"	↓
9	3.46	—	5.25	630 ± 65	"	↓
10	2.60	+	4.58	475 ± 40	"	Non-illuminated region
11	2.92	—	4.48	550 ± 50	"	↓
12	2.12	+	2.23	540 ± 35	$2e$	

any fast decay products.

In one case (No. 12, Table III), the stopping of a positive particle in a copper plate 3 mm thick was accompanied by the release of a small electron cascade (Fig. 15). In another case of a stopping positive particle (No. 5, Table III), the release of two electrons is observed. The quality of this picture, however, is poorer, and the particle stopped near the edge of the chamber. The stopping of the negative particles with the mass $\sim 550 m_e$ resembles rather the stopping of negative μ -mesons and differs greatly from that of K -particles and fast π -mesons (see Fig. 2).

On the basis of our data, it is possible to estimate roughly the intensity of the anomalous particles relative to μ -mesons in the same range interval. 255 μ -mesons with ranges between 2 and 5 cm Pb, and 10 particles with the mass $\sim 550 m_e$ were recorded in the second series of measurements. Under the assumption of an isotropic angular distribution of the investigated particles, 15 particles were found compared to 1600 μ -mesons which is about 1%, the correction for recording efficiency having been applied. The accuracy of this estimate is small, and if we account for the angular distribution of the μ -mesons the above ratio will be

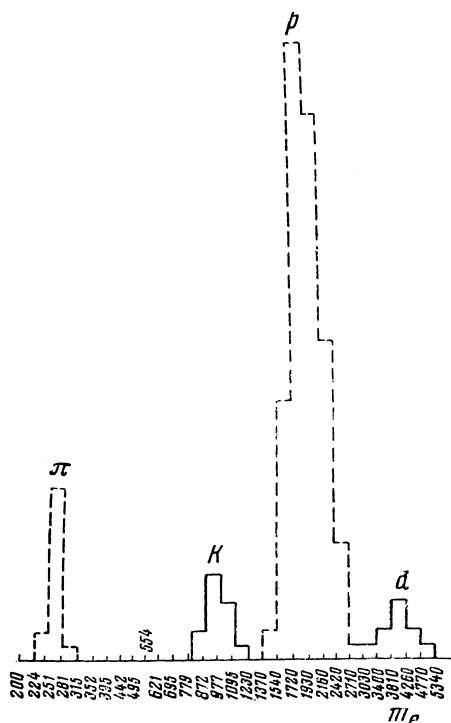

FIG. 14. Mass spectrum of particles produced in stars (without aperture correction)

closer to 0.5%.

Naturally, the question arises whether such a small number of particles with mass $550 m_e$ can be explained by μ -mesons whose range or momentum were determined with a large error due to random causes. It should be noted first that, for a mean square error of $\sim 50 m_e$, the appearance in the spectrum of a group of 11 particles with mass between 450 and $650 m_e$ on account of μ -mesons is completely excluded. Secondly, if the 11 particles of the mass $\sim 550 m_e$ appeared in the mass spectrum because of the errors of measurements, there would be much greater numbers of particles with measured mass in the range of 300 – $450 m_e$.

TABLE IV

No. of case	Radius of curvature from counter data, cm	Radius of curvature from entrance and exit angles, cm
1	148	161
4	174	158
5	222	200
7	232	240
8	170	174
9	256	244
11	216	192

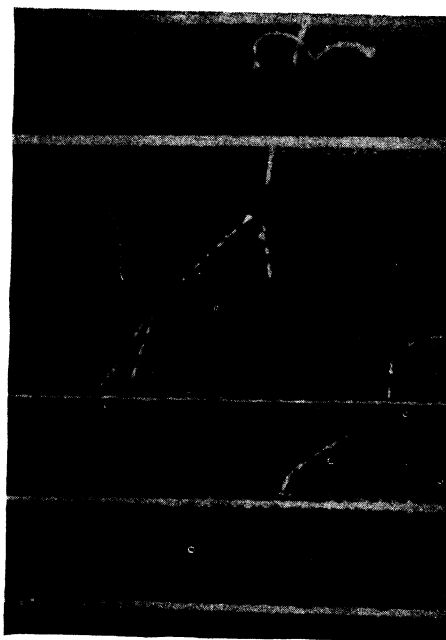

FIG. 15. Stopping of a positive particle accompanied by a small electron cascade. Mass equal to $540 m_e$ (range-momentum method)

It can be seen from Fig. 12 that not a single particle was found in this interval.

It has been of considerable interest to investigate the spectrum of particles which entered the set-up from the outside, traversing the thin lid of the upper chamber.* This spectrum is shown in Fig. 16. In contrast to the spectrum of particles locally produced in stars, μ -mesons and a group of particles with mass $\sim 550 m_e$ are observed, while π -mesons and K -particles are completely absent.

The spectrum in Fig. 16 is given without aperture correction, which is very large for μ -mesons with

TABLE V

Type of particle	Mass determined from range and scattering angles, m_e	Number of scattering angles
μ	180 ± 27	100
π	290 ± 47	70
K	1050 ± 200	52
p	1750 ± 190	200
500–600 m_e	525 ± 140	46

*A small amount of particles locally produced in the cover may be present in this spectrum.

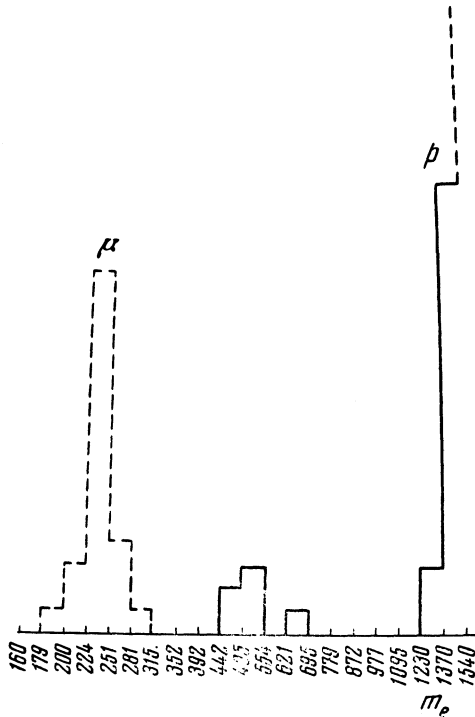

FIG. 16. Mass spectrum of particles entering the apparatus from the outside and traversing the thin cover of the upper chamber (without aperture correction).

momenta in the $1.4\text{--}1.7 \times 10^8$ ev/c range. This is connected with the fact that the overwhelming majority of the μ -mesons stopping in the illuminated region of the lower chamber must enter the upper chamber at a large angle to the zenith, thus missing the thin cover. It is difficult to make the exact aperture correction in that case, and the group of μ -mesons actually observed during the experiment is shown in Fig. 16 outlined by the dashed line. Due to the absence of π -mesons, the resolution between μ -mesons and particles with mass $550 m_e$ is still better. It can be seen in Fig. 16 that there is no particle in the interval of $300\text{--}400 m_e$.

Since, in our experiments, the mass of particles was determined by the range-momentum method, we undertook an exact analysis of the trajectories of the particles with mass $\sim 550 m_e$ both in the telescope and in the lower chamber. For seven particles it was possible to determine the value of the momentum not only from the coordinates of the telescope counters but also from the angle of entrance of the particle into the magnet gap out of the upper chamber and the angle of exit of the particle from the gap into the lower chamber. The values of the radii of curvature of the trajectories of these particles, measured by the two inde-

pendent methods, are given in Table IV. It can be seen that both methods yield similar results. This fact indicates that the possibility of large random errors of momentum measurements of the group of particles of interest is excluded. The analysis of the tracks of these particles in the lower chamber ascertained that large errors of range measurements also are improbable.

It was found that:

1. All particles listed in Table III stopped far from the limits of the illuminated region and the glass windows of the chamber.

2. In the majority of cases, it was possible to estimate qualitatively an increase in the track density near its end by means of comparison with the density of proton tracks.

3. The measurements of the angles of multiple scattering in lead plates show that the mean square angle of scattering of particles of the $500\text{--}600 m_e$ group increases towards the end of the track. It equals $12 \pm 2^\circ$ for the residual range of 8.5 gm/cm^2 , $9.8 \pm 2^\circ$ for 17 gm/cm^2 and about 6° for 30 gm/cm^2 . The measured values of the mean square angle for μ -mesons of corresponding ranges were found to be equal to 18° , 13° and 9.9° respectively.

4. The measured value of the mean square scattering angle of μ -mesons with momenta equal to $2.4\text{--}2.6 \times 10^8$ ev/c at the point of scattering was 4.8° . This value, as well as the angular distribution of the scattering of μ -mesons with these values of momentum, is very different from those observed for the particles of the $500\text{--}600 m_e$ group with similar momenta.

All the data of this section indicate that the particles with mass $500\text{--}600 m_e$ cannot be identified either as π - and μ -mesons or K -particles.

6. DETERMINATION OF THE MASS OF PARTICLES FROM THEIR SCATTERING AND RANGE

We determined the mass of particles independently from the momentum measured in the magnetic spectrometer, by means of measurement of the angle of scattering of the particle in the lead plates and of the residual range in the point of scattering. Experimentally, it is most convenient to measure the projection of the scattering angle on a given plane. Having found the value of $\bar{\varphi}$ or $\bar{\varphi}^2$ for a group of identical particles, and making use of the momentum-range relation, and of the theory of multiple scattering of particles, it is possible to determine their mass. This method of mass determination from the scattering of particles in a multiple-plate cloud chamber was used earlier by Rossi, Annis and others¹⁶, who made use of the

theory of scattering by nuclei to finite size, developed by Olbert.¹⁷

The mass of the particle is given by the following formula:

$$\left[\frac{1}{n} \sum \varphi_i^2 R_i^{2\alpha} \right]^{1/2} = k \left(\frac{m_e}{m} \right)^{1-\alpha},$$

where use is made of the mean square value of angle projections, n is the number of scattering angles, R is the residual range, m is the mass to be determined, $\alpha = 0.55$ and k is constant, slowly varying with v/c .

The influence of the finite size of nuclei on the scattering of particles was recently more correctly taken into account by M. L. Ter-Mikaelian, who made use of the experimental data on the scattering of fast electrons in lead. He also determined the coefficients k for finite-size nuclei more accurately.

For each group of homogeneous particles of the spectrum shown in Fig. 12, we carried out a second determination of the mass from the scattering angles and the range. The results are given in Table V. It can be seen that the second method of mass determination gives correct values of the mass of known particles. Making use of ~ 100 scattering angles, we obtain sufficient accuracy of the mass determination for a group of particles.

We estimated the possible fluctuations in the following way: the value of mass was determined for 25 groups of particles, each group consisting of ten randomly chosen μ -mesons. The mean number of scatters for each group was not more than 40–50. For no group did the value of mass amount to $500 m_e$. The maximum value of the mass was in each case smaller than the mass of the μ -meson. For particles with mass $\sim 550 m_e$, the value of mass was determined both from $\bar{\varphi}$ and $\bar{\varphi}^2$. The results of the mass determination for the group of particles with mass 500–600 m_e are given in the end of the Table, and evidently are in good agreement with mass values obtained by means of the range-momentum method. This agreement between values of the mass of particles of this group, obtained by means of various independent methods, constitutes another indication of the existence of particles with the mass $\sim 550 m_e$.

7. CONCLUSION

A magnetic spectrometer with two cloud chambers was used for the analysis of the masses of charged cosmic ray particles. It is evident from the results of measurements given in Sec. 5 that, as in

preliminary experiments, two groups of particles—particles with mass $\sim 1000 m_e$ (K -particles) and particles with mass $\sim 550 m_e$ —are observed in the mass spectrum between the π -mesons and the proton. It has been shown, that when only the particles locally generated in matter above the set-up are considered, the group of particles with mass $\sim 550 m_e$ is completely absent and the mass spec-

trum consists of π -mesons, K -particles, protons and deuterons. The mass spectrum of particles produced in stars, shown in Fig. 14, is in good agreement with the observations of a number of authors, who used a cloud chamber controlled by a star or shower produced by fast primaries in the matter above the set-up (Leprince-Ringuet, Rossi and others). The frequency of observation of K -particles as compared with π -mesons in the same range interval was in our experiments found to be of the order of 0.08, in accordance with data obtained by several workers who obtained $N_k / N_\pi \approx 0.07$ for cosmic rays.

In the total mass spectrum (Fig. 12), we found a group of 11 particles, whose mass, determined from range-momentum measurement as well as from range-scattering measurements, was found to lie between 500 and 600 m_e . This result sharply contradicts all experiments on the mass of cosmic ray particles carried out by means of cloud chambers and emulsions, in the course of which no mesons with mass $\sim 500 m_e$ were detected. We will now look into this matter more closely. First of all, it is found that in practically all cloud chamber experiments, the mass measurements were carried out for particles locally produced in the matter of the recording apparatus.

It is necessary, therefore, to compare the results of such measurements with the mass spectrum of Fig. 14, with which they are in good agreement, and not with the total mass spectrum. In several cases, we were able to deduce directly that the particles of the anomalous group entered the apparatus from the outside, similarly to μ -mesons.

If the lifetime of such particles is long, it is possible that, through accumulation in a column of air, they can amount to a considerable part of the number of K -particles locally produced above the apparatus. It is possible that this is the cause of the difference between the total mass spectrum and the mass spectrum of locally produced particles.

Our method of mass determination is based on the establishment of the fact that the particles are stopping, which is judged qualitatively from the increase in the track density in the chamber. Together with the mass determination from range, mo-

mentum, and scattering measurements, we deem it necessary to determine with good accuracy the specific ionization of the individual particles. This will make it possible to determine the mass of the particle by an independent method—from the ionization and momentum. Only such measurement will help us reach the final conclusion about the existence of particles with mass $\sim 500 m_e$. We have already started a new series of measurements in which the specific ionization of particles is determined before the particle enters the cloud chamber by means of multiple-layer proportional counters. Systematic and accurate mass measurements of a large number of particles stopping in emulsion stacks, independently of the character of the process at the end of the track, would also be of great importance.

Finally, the authors wish to express their gratitude to M. Daion, G. Merzon, A. Galper, F. Arutiunian and G. Badalian for their part in the measurements and in the evaluation of results, and to B. Dolgosheinyi and A. Shmeleva for the great help in the evaluation of the results of measurements.

1 Alikhanian, Alikhanov, Morozov, Muskhelishvili and Khimian, Dokl. Akad. Nauk SSSR 58, 1321 (1947).

- 2 A. Alikhanian and A. Alikhanov, J. Exptl. Theoret. Phys. (U.S.S.R.) 21, 1029 (1951).
- 3 Alikhanian, Dadaian and Shostakovich, Dokl. Akad. Nauk SSSR 82, 693 (1952).
- 4 Kharitonov, Marikian and Alikhanian, Dokl. Akad. Nauk SSSR 80, 201 (1952).
- 5 A. Alikhanian and V. Kharitonov, Dokl. Akad. Nauk SSSR 85, 295 (1952).
- 6 Daniel, Davis, Mulvey and Perkins, Phil. Mag. 43, 753 (1952).
- 7 R. Daniel and D. Perkins, Proc. Roy. Soc. (London) 221A, 351 (1954).
- 8 A. Alikhanian, J. Exptl. Theoret. Phys. (U.S.S.R.) 21, 1063 (1951).
- 9 L. Landau, J. Exptl. Theoret. Phys. (U.S.S.R.) 8, 201 (1944).
- 10 A. Alikhanian and V. Kharitonov, Dokl. Akad. Nauk SSSR 92, 6 (1953).
- 11 Eliseev, Liubimov and Kosmacherskii, Dokl. Akad. Nauk SSSR 90, 995 (1953).
- 12 Alikhanian, Kirillov-Ugriumov, Shostakovich and Fedorov, Dokl. Akad. Nauk SSSR 92, 255 (1953).
- 13 Alikhanian, Kirillov-Ugriumov, Shostakovich, Fedorov and Merzon, Dokl. Akad. Nauk SSSR 92, 915 (1953).
- 14 Alikhanian, Kirillov-Ugriumov, Shostakovich, Fedorov and Merzon, Dokl. Akad. Nauk SSSR 92, 511 (1953).
- 15 Daion, Fedorov, Merzon and Shostakovich, PTE 1, (1957).
- 16 Bridge, Peyrou, Rossi and Safford, Phys. Rev. 90, 921 (1953).
- 17 Annis, Bridge and Olbert, Phys. Rev. 89, 1216 (1953).

Translated by H. Kasha
209