

- ⁶W. Lakin, Phys. Rev. **98**, 139 (1955).
⁷E. Clementel and C. Villi, Nuovo cimento **2**, 1165 (1955).
⁸F. Mandl and T. Regge, Phys. Rev. **99**, 1478 (1955).
⁹S. M. Bilen'kii and L. I. Lapidus, Report of Institute of Nuclear Research of the Academy of Sciences of the U.S.S.R., 1955.
¹⁰O. D. Cheishvili, J. Exptl. Theoret. Phys. (U.S.S.R.) **30**, 1147 (1956), Soviet Phys. JETP **3**, 974 (1957).
¹¹R. L. Garwin, Phys. Rev. **85**, 1045 (1952).
¹²V. B. Berestetskii, Dokl. Akad. Nauk SSSR **94**, 421 (1954).
¹³S. C. Wright, Phys. Rev. **99**, 996 (1956).

Translated by W. H. Furry

30

SOVIET PHYSICS JETP

VOLUME 6, NUMBER 1

JANUARY, 1958

ELECTRON DENSITY FLUCTUATIONS AND THE SCATTERING OF RADIO WAVES IN THE IONOSPHERE

IA. L. AL'PERT

Institute for the Study of Terrestrial Magnetism, the Ionosphere, and Radio Wave Propagation

Submitted to JETP editor January 19, 1957

J. Exptl. Theoret. Phys. (U.S.S.R.) **33**, 213-224 (July, 1957)

A description is given of results from a determination of electron density fluctuations obtained by measuring the "turbidity coefficient" of the ionosphere and the energy scattered at very high frequencies. The linear dimensions ξ of inhomogeneities at ~ 80 km, which are effective in uhf scattering, were also determined. The formulas employed were based on an expression for the scattering cross section σ which was obtained with the auto correlation coefficient $\rho(r) \sim \exp\{-(r/\xi)^2\}$. The author concludes that when the ionosphere is sounded at frequencies below the critical frequency, the received signal comprises in addition to the "specularly" reflected wave also waves which are principally scattered forward and latter reflected at higher ionospheric levels. In oblique distant uhf transmission through the ionosphere scattering from inhomogeneities of optimum size makes the largest contribution.

1. INTRODUCTION

IT is known that one of the principal characteristics of the "calm" unperturbed ionosphere is its "statistical inhomogeneity," the mechanisms of which are still unknown.^{1,2} It has been argued that turbulence and in some instances plasma oscillations and waves participate in these processes. However, all such discussions are of a very tentative nature since the theory of the phenomena is still relatively undeveloped. There is also very little reliable experimental information available to serve as a basis for any theoretical model.

Up to the present time the following parameters have been determined experimentally:

1. The ranges of linear dimensions ξ_s of the inhomogeneities, principally at altitudes $z \approx 100 - 120$ km and $\approx 250 - 350$ km. From experiments with vertical sounding of the ionosphere the most frequently encountered values are $\xi_0 \sim 200 - 300$ m.
2. The ranges of random velocities v_s of the inhomogeneities; the values $v_0 \sim 1 - 3$ m/sec have been obtained.

3. The horizontal drift velocities u_x at $z \sim 80 - 120$ km $u_0 \sim 70$ m/sec, and at $z \sim 250 - 350$ km $u_0 \sim 100$ m/sec,* with

$$(du_0/dz)_{100 - 130 \text{ km}} \sim 3.4 \text{ m/sec/km}$$

and

$$(du_0/dz)_{250 - 500 \text{ km}} \sim 1 \text{ m/sec/km.}$$

4. The ranges of the angles θ of scattered waves, for which the values $\theta_0 \sim 2 - 5^\circ$ were obtained

5. The degree of turbulence of the ionosphere $\beta_0^2 = a_0^2 / \Sigma a_S^2$, which is the ratio between the energy of a specularly reflected wave and the total energy of scattered waves; the values $\beta_0 \sim 2 - 4$ were obtained.

However, there has thus far been an absence of data on the fluctuations of electron density in the inhomogeneities, which are represented by the quantity $(\Delta N/N)^2 = (\delta N)^2$. It is quite evident that without knowledge of δN it is impossible to obtain a complete physical picture of the effects under discussion. In particular, it is not possible to make calculations for uhf transmission to great distances, which has attracted much attention in recent years.

Some methods are described below for determining δN and in some instances ξ , and the experimental values are given.

It is shown that the previously accepted picture of scattering in the ionosphere must be changed in some instances. Thus the random oscillations detected in vertical sounding of the ionosphere below the critical frequency do not result from backward scattering (with $\theta \sim 0$), as has hitherto been supposed, but principally from forward scattered waves ($\theta \sim 0$) which are subsequently reflected at higher ionospheric levels. This produces, in particular, the narrow angular spread of the waves which is observed experimentally. In oblique distant uhf transmission inhomogeneities of optimum size are the most important factor in the scattering rather than the angle function $\sin^{-n}(\theta/2)$ which is usually analyzed in the literature. Calculations and measurements are brought into agreement when this fact is taken into account.

The discrepancy found in the literature between the experimental results and the calculations is also apparently a result of improper utilization of the various ionospheric parameters.

When the entire set of the above-mentioned parameters is examined it is a striking fact that they change very little from the beginning of the ionosphere to the region of maximum ionization, despite the fact that the density of neutral particles and accordingly the mean free path changes by a factor of approximately $10^5 - 10^6$, the electron concentration by $10^3 - 10^4$ and the temperature by 5 - 7. It is therefore very important that further experiments should include a detailed investigation of the altitude dependence of these parameters. At the end of this paper certain "dimensional" formulas of the theory of turbulence are used to estimate the quantities under investigation. In a number of instances the estimates agree with the measurements, but for a number of reasons this is insufficient for the drawing of any conclusions.

2. DEDUCTION AND ANALYSIS OF THEORETICAL FORMULAS

(a) Effective Scattering Cross Section

We assume that the inhomogeneous medium V is characterized by any irregular function $\Delta\epsilon$ representing the departure of the dielectric constant from its average value ϵ , and that the linear dimensions of V are large compared with the scale ξ of an inhomogeneity.† Then the complex energy density of the secondary field of volume dipoles excited by the incident wave $E_0 \exp\{i(\omega t - kR_0)\}$ is at the point of observation

$$\frac{c}{4\pi} (EH^*) = \frac{cV\bar{\epsilon}}{4\pi} \frac{k^4}{(4\pi)^2} \iint (\Delta\epsilon) (\Delta\epsilon')^* \frac{E_0 E_0' \sin\psi \cdot \sin\psi'}{RR'} \exp\{-ik[(R - R') + (R_0 - R_0')]\} dV dV', \quad (1)$$

where the notation can be understood from Fig. 1, $k = 2\pi/\lambda$, primes denote the values of quantities at the point P' located a distance r from the point P , and asterisks denote complex conjugates.

Equation (1) is usually calculated as follows. We separate in the double integral

$$\int_V (\Delta\epsilon) (\Delta\epsilon')^* dV = \overline{(\Delta\epsilon) (\Delta\epsilon')^*}, \quad (2)$$

*The largest inhomogeneities with velocities $u_0 \sim 200 - 300$ m/sec are evidently to be observed when the ionosphere is in a perturbed state.

†Of course, ϵ can itself be a function of position in the medium.

which is the autocorrelation function of $\Delta\epsilon$. Since for the ionosphere a good approximation of the correlation coefficient, especially according to experimental data on short waves,^{1,5} is given by $\rho(r) \sim \exp(-r^2/\xi^2)$, Eq. (2) can be written as

$$\int_V (\Delta\epsilon)(\Delta\epsilon)^* dV = V \overline{\Delta\epsilon^2} e^{-r^2/\xi^2}, \quad \overline{\Delta\epsilon^2} = \frac{1}{V} \int (\Delta\epsilon)^2 dV. \quad (3)$$

When (3) is substituted in (1) we find that the integrand in (1) decreases rapidly, so that the integral is effectively contained within distances r amounting to a few lengths ξ . Therefore, since R and R_0 are usually considerably greater than ξ , it can be assumed that the factor

$$E_0 E_0' \sin \psi \sin \psi' / RR' \approx E_0^2 \sin^2 \psi / R^2$$

in the integrand is almost unchanged within a radius of a few ξ , so that it can be removed from under the integral sign, after which the limits of integration can be extended to infinity. The calculation of the effective part of the energy P_r [the real part of (1)] at the receiving point gives after a few transformations

$$P_r = \frac{c \sqrt{\epsilon}}{4\pi R^2} \left(\frac{E_0^2 k_0^4 \sin^2 \psi}{4\pi} \right)^2 \frac{V \overline{\Delta\epsilon^2}}{2k_0 \sin(\theta/2)} \int_0^\infty e^{-r^2/\xi^2} r \sin\left(2k \sin \frac{\theta}{2}\right) r dr \quad (4)$$

If we now introduce the scattering cross section of the medium, defined as the ratio of the energy P_s scattered by unit volume into unit solid angle to the energy p_0 of the incident wave, i.e., assuming

$$P_s / p_0 = \sigma, \quad (5)$$

with

$$p_0 = c \sqrt{\epsilon} E_0^2 / 4\pi, \quad P_r = R^{-2} \int P_s dV,$$

using for the ionosphere the formula

$$\epsilon = 1 - 4\pi N e^2 / m\omega^2 = 1 - \omega_N^2,$$

and assuming $\overline{(\Delta N/N)^2} = (\delta N)^2$, we obtain from (4)*

$$\sigma = (\delta N)^2 \left(\frac{\omega_N}{\omega} \right)^4 \frac{V \pi}{8\lambda} \left(\frac{2\pi\xi}{\lambda} \right)^3 \sin^2 \psi \exp \left\{ - \left(\frac{2\pi\xi}{\lambda} \sin \frac{\theta}{2} \right)^2 \right\}. \quad (6)$$

We must point out here that the deduction of (6) is evidently based on the assumption that all of the physical characteristics of the problem are contained in σ . Therefore, when the autocorrelation function is known from experiment and a rigorous solution based on the actual mechanism has not been obtained, the accuracy of the calculation of the scattered energy depends on the accuracy of the approximation for the autocorrelation coefficient.

An examination of (6) shows that when $\xi/\lambda \lesssim 1$ energy is scattered predominantly at the angle given by

$$\sin(\theta/2) \sim \lambda / 2\pi\xi. \quad (7)$$

Thus when forward-scattered waves, for which $\theta \sim 0$, can reach the receiving point the field energy at the point of reception is determined mainly by scattering from the largest inhomogeneities in the medium, in which case the smallest possible value of the angular range is obtained. In lateral scattering, when waves can be received only in a definite given direction θ the optimum size of the inhomogeneities, scattering from which provides the largest part of the received energy, is determined by the equation $d\sigma/d\xi = 0$, which gives

Equation (6) differs from the corresponding formula derived by Pekeris,³ which was subsequently used by Booker and Gordon⁴ because in these two references $\rho(r) \sim e^{-r/\xi}$ (see also footnote marked on page 174).

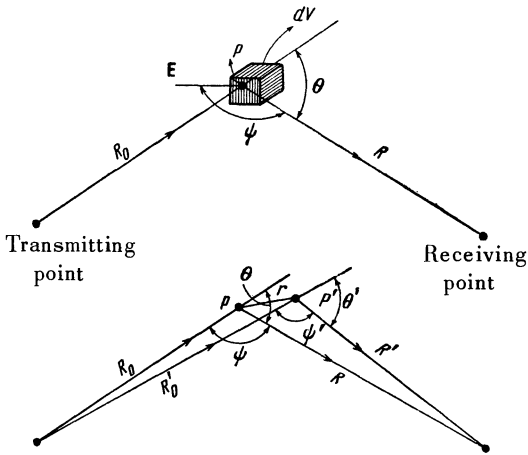

FIG. 1. The geometry underlying the calculation of the scattering cross section.

$$\xi_m = (\sqrt{3}/2\sqrt{2}\pi)\lambda/\sin(\theta/2). \quad (7a)$$

Furthermore, if we remember that the fluctuations of electron density ΔN must increase with N so that δN^2 does not vary much as N changes, we obtain $\sigma \sim \omega_N^4 \sim N^2$. Therefore if the range of sizes of inhomogeneities is identical in different ionospheric regions the scattered energy increases in proportion to N^2 .

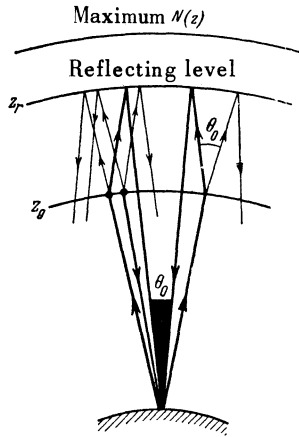

FIG. 2. The geometry for the calculation of the energy scattered during vertical sounding of the ionosphere.

We shall now for two kinds of experiments consider what possibilities exist for determining the parameters of the ionosphere from measurements of the energy in scattered waves.

(b) Vertical Sounding of The Ionosphere

We shall assume as a basic fact that in vertical sounding of a "calm ionosphere"¹ the angular spread of the received waves is narrow. The calculations are considerably simplified as a result. Indeed, an element of the scattering volume can be taken to be $dV \approx \pi(z\theta_0/2)^2 dz$ so that the received energy at the observation point is

$$P_r = \int_V p_0 \sigma dV = \frac{\pi\theta_0^2}{4} \int_{z_0}^{z_r} p_0 \sigma z^2 dz \approx \sum a_s^2; \quad (8)$$

where z_0 and z_r are, respectively, the heights of the beginning of the layer and the point of wave reflection with $\epsilon = 0$ ($\omega_N^2 = 1$) (Fig. 2). If the dependence of the electron concentration is given by a parabolic curve, which is often in good agreement with experiment especially for a "quiet ionosphere," we have

$$N(z) \sim \frac{\omega_N^2}{\omega^2} = \frac{\omega_c^2}{\omega^2} \left[1 - \left(\frac{z_m + z_0 - z}{z_m} \right)^2 \right], \quad (9)$$

$$z_r = z_0 [1 + \alpha(1 - m_0)], \quad \alpha = z_m / z_0, \quad m_0 = \sqrt{1 - (\omega/\omega_c)^2} = \sqrt{1 - (\lambda_c/\lambda)^2},$$

where z_m is the half-thickness of the parabolic layer and ω_c is its critical frequency.

We now assume on the basis of the foregoing considerations that $\theta_0 \sim \lambda/2\pi\xi$ [see (7)], that is, we shall take into account only a forward beam, since $\xi_0 \gg \lambda$. If θ_0 is almost constant over the entire path of the wave the exponential term in (6)* is everywhere of the order e^{-1} . Furthermore, since damping is neglected here, $p_0 = P_t/4\pi z^2$ (P_t is the radiating power of the source) and the energy of a specularly reflected wave is given by $a_0^2 = P_t/16\pi z_r^2$. We have finally

$$\frac{\sum a_s^2}{a_0^2} = (\beta_0^2)^{-1} = \frac{\pi V \pi}{4e} \frac{\lambda^2 \xi_0}{\lambda_c^4} (\alpha + 1 - m_0)^2 \int_{z_0}^{z_0 [1 + \alpha(1 - m_0)]} (\delta N)^2 \left[1 - \left(\frac{z_m + z_0 - z}{z_m} \right)^2 \right]^2 \frac{dz}{z^2} \quad (10)$$

or after calculations in which $(\delta N)^2$ is taken outside of the integral sign we obtain

$$(\delta N)^2 = \frac{4e}{\pi V \pi} \frac{\lambda_c^4}{\xi_0 z_m \lambda^2 (\alpha + 1 - m_0)^2 \beta_0^2 M(\alpha, m_0)}, \quad (11)$$

where †

$$M = \frac{1 - m_0}{\alpha + 1 - m_0} \left\{ 4\alpha(\alpha + 1)(\alpha + 2) + 2(1 - m_0)(\alpha + 1)(\alpha + 2) - \frac{2}{3}(1 - m_0)^2(\alpha + 3) + \frac{(1 - m_0)^3}{3} \right\} - 4\alpha(\alpha + 1)(\alpha + 2) \ln \left(1 + \frac{1 - m_0}{\alpha} \right). \quad (12)$$

Thus when the values of the parameters in (11) are known it is possible to determine experimentally the fluctuations of electron density in the reflecting region of the ionosphere. Since (10) depends principally on the upper limit of z_r , δN frequently characterizes a region of relatively small thickness Δz adjacent to the point z_r .

It must be kept in mind that here as throughout this paper the dependence of wavelength on height is not taken into account. This will be done in a separate paper.

*For waves scattered backward we obtain under actual conditions $\sim e^{-40} - e^{-50}$, that is, negligibly small values of P_r .

†We note that for real ionospheric parameters (12) is the difference between two approximately equal quantities, so that the numerical work must be very accurate.

(c) Oblique Propagation

When scattered waves are received at the angle θ to the incident wave at frequencies for which the ionosphere is transparent, and especially at very high frequencies, the energy P_r at the observation point is calculated as follows. In such experiments directional antennas are usually employed. When the receiving and transmitting antennas have identical directional characteristics $f(\alpha, \gamma)$ (where α and γ are angles measured in the vertical and horizontal planes, respectively) and their maxima are in the direction of the midpoint of the scattering region (Fig. 3), the received energy P_r scattered by an elementary volume dV is

$$\Delta P_r = \sigma \rho_0 \Delta \Omega_r dV = \sigma \left\{ \frac{P_t g_0 |f(\alpha, \gamma)|^2}{4\pi R_0^2} \right\} \frac{A'_0}{R^2} dV, \quad (13)$$

where $\Delta \Omega_r A'_0/R^2$ is the solid angle of reception of the antenna, $A_0 = \lambda^2 g_0/4\pi$ is the cross section, $g_0 = 4\pi/\int |f(\alpha, \gamma)|^2 d\Omega$ is its maximum gain and

$$\rho_0 = P_t g_0 |f(\alpha, \gamma)|^2 / 4\pi R_0^2.$$

Integrating over the entire volume (over the angles α and γ of the transmitting point and the angles α' and γ' of the receiving point) we obtain

$$\frac{P_r}{P_t} = \frac{g_0^2 \lambda^2}{(4\pi)^2} \iiint_{x, \gamma, R} \frac{\sigma |f(\alpha, \gamma)|^2 |f(\alpha', \gamma')|^2}{R_0^2 R^2} dV. \quad (14)$$

It can easily be seen that (14) is a generalization of the so-called radar formula. Equation (14) can be integrated only under certain simplifications which in practice, however, satisfy the accuracy requirements of such experiments.

It is customary in such calculations to move the antenna directivity functions outside of the integral sign and, depending on their location with respect to the scattering region g_0 , to replace them with the effective antenna gain $g = 4\pi A/\lambda^2$ (or effective area A) which is calculated for a given antenna. Also, when the angles of radiation of the antennas are small the integrand is determined principally by the dependence of all quantities on z , so that in the integrand we can write the values of θ , R_0 and R along the line $00'$, which is the axis of symmetry of the scattering volume, we can assume that

$$dV = \frac{R_0 d\alpha}{\sin(\theta_0/2)} R_0 \cos \alpha d\gamma \frac{dz}{2}, \quad R_0 \sim R = \frac{z}{\sin(\theta_0/2)}$$

and take $\theta_0/2 \sim \alpha$ (neglecting the spherical shape of the earth). As a result, instead of (14) we obtain

$$\frac{P_r}{P_t} = \frac{g^2 \lambda^2}{(4\pi)^2} \iiint_{\gamma_1, \alpha_1, z_1}^{\gamma_2, \alpha_2, z_2} \frac{\sigma(z, \alpha)}{z^2} \sin \alpha \cos \alpha d\alpha d\gamma dz \quad (15)$$

or

$$\frac{P_r}{P_t} = \frac{g^2 \lambda^2}{2(4\pi)^2} (\gamma_2 - \gamma_1) \int_{\alpha_1}^{\alpha_2} \exp \left\{ - \left(\frac{2\pi\xi}{\lambda} \right)^2 \sin^2 \alpha \right\} d \sin^2 \alpha \int_{z_1}^{z_2} \frac{\sigma(z)}{z^2} dz, \quad (16)$$

where $\gamma_1, \gamma_2, \alpha_1, \alpha_2$ characterize the angular direction of the effective radiation patterns of antennas that radiate into the scattering region and

$$\sigma(z) = (\delta N)^2 (\omega_N / \omega)^4 (\sqrt{\pi} / 8\lambda) (2\pi\xi / \lambda)^3.$$

It is easily seen that the integral over z in (16) can be expressed through the integral in (10) which was calculated above. Therefore, assuming that $z_1 \leq z_0$ and $z_2 \geq z_0 + 2z_m$, we have

$$\frac{P_r}{P_t} = \frac{g^2}{2^2 V \pi} \left(\frac{\omega_c^4}{\omega} \right) \frac{\xi (\gamma_2 - \gamma_1)}{z_m} (\delta N)^2 M(\alpha, m_0) \left\{ \exp \left\{ - \left(\frac{2\pi\xi \sin \alpha_1}{\lambda} \right)^2 \right\} - \exp \left\{ - \left(\frac{2\pi\xi \sin \alpha_2}{\lambda} \right)^2 \right\} \right\}. \quad (17)$$

We note that in the calculation of (16) it was assumed that ξ/λ is independent of z .

The derivation of (17) is based on the inherent assumption that the region which is irradiated by the antennas is quite extensive in height and that the waves scattered by the region as a whole make a con-

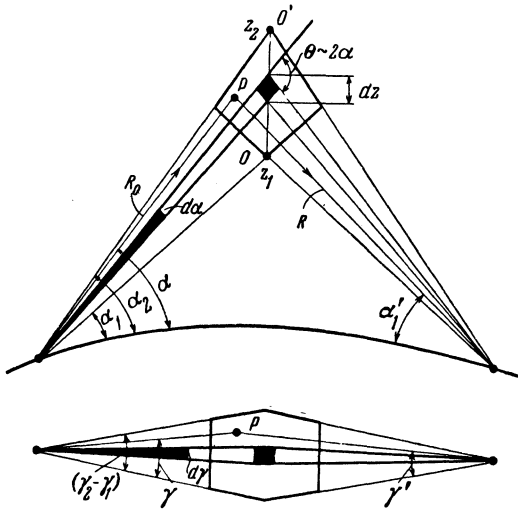

FIG. 3. The geometry for the calculation of the energy scattered in oblique propagation.

siderable contribution to the field at the receiving point. Such conditions regarding the magnitude of $z_2 - z_1$ are realized, for example, in connection with short waves. But is not known whether the entire ionosphere then participates in the scattering. For a number of reasons it can be assumed that this is not the case, and the energy can be calculated more simply by taking the effective scattering region to be very thin. Such conditions are undoubtedly realized in the case of very short waves. The solid angles of radiation of the antennas used in these experiments are indeed very small, as are the dimensions of V , so that we can take $\sigma \sim \text{const}$, $R_0 \sim R$ and then write (see Fig. 4)

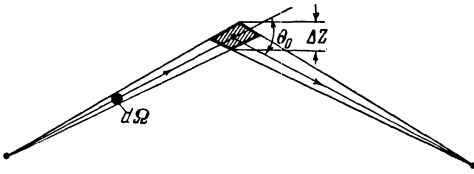

FIG. 4. The geometry underlying energy calculations at ultra high frequencies.

$$V = \frac{R_0^2 \Delta\Omega}{\sin(\theta/2)} \Delta z = \frac{R^2 \lambda^2 \Delta z}{A \sin(\theta/2)},$$

which by utilizing (14) gives

$$\frac{P_r}{P_i} = (\delta N)^2 \frac{V \sqrt{\pi}}{8\lambda} \left(\frac{\omega_N}{\omega}\right)^4 \left(\frac{2\pi\xi}{\lambda}\right)^3 \frac{A\Delta z}{R_0^2 \sin(\theta/2)} \exp\left\{-\left(\frac{2\pi\xi}{\lambda} \sin \frac{\theta}{2}\right)^2\right\}. \tag{18}$$

It is easily seen that (18) enables us to determine δN and ξ . Thus, for example, when P_r is measured at different distances and fixed frequencies subject to the assumption that under the experimental conditions $(\delta N)^2$, (ω_N/ω) and ξ remain unchanged, we obtain for the ratio of the energies at different points

$$\frac{(P_r)_2}{(P_r)_1} = \frac{R_1^2}{R_2^2} \frac{\sin(\theta_1/2)}{\sin(\theta_2/2)} \exp\left\{-k^2 z^2 \left(\sin^2 \frac{\theta_2}{2} - \sin^2 \frac{\theta_1}{2}\right)\right\}, \tag{19}$$

in which only ξ is unknown. It is similarly possible to determine ξ from measurements of P for different frequencies at a single point. Furthermore, from a knowledge of ξ and the other parameters of the ionosphere which characterize the experiments $(\delta N)^2$ can be determined from (18) by measuring P_r at different distances and frequencies.

A corresponding analysis of the experimental results is given below.

3. ANALYSIS OF THE EXPERIMENTAL RESULTS. VALUES OF δN AND ξ

(a) Vertical Sounding of the Ionosphere

The method described in Refs. 1 and 6 has been used to determine the coefficient of turbidity β under various conditions. A complete analysis of the data would proceed as follows. For each value of β_s , δN_s must be calculated from (11), using in each instance the individual values of z_0 , z_m , ω , ω_c and ξ_s . It is thus possible to obtain distribution curves and the dependence of δN on height and to investigate their variation under different conditions. Such a detailed treatment of the experimental results will be the subject of a special paper. Here we are primarily interested in determining δN from the measurements of β . For this purpose we shall make use of the theoretical curves of $\{\beta_0^2 (\delta N)^2\}$ (Figs. 5, 6) which were calculated according to (11) and (12) for a number of characteristic parameters of the different ionospheric regions, and we shall also use all of the measurements of β (Fig. 7).

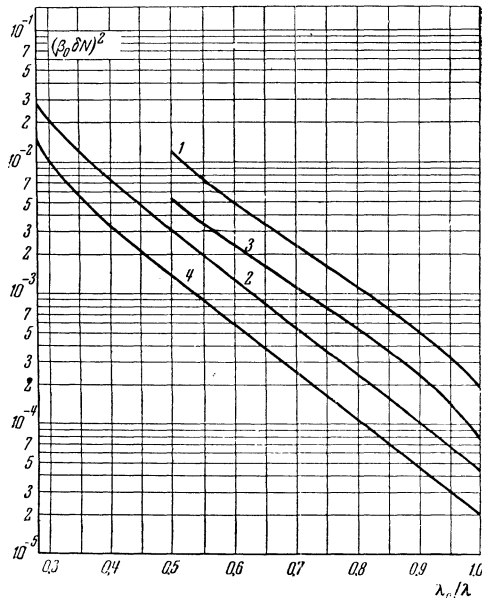

FIG. 5. Theoretical dependence of $(\beta_0 \delta N)^2$ on λ_c/λ for the F layer of the ionosphere with $\xi_0 = 200$ m and $z_0 = 250$ km. Curves 1 and 2 correspond to $z_m = 100$ km and $\lambda_c = 50$ m and 25 m; curves 3 and 4 correspond to $z_m = 200$ km and the same values of λ_c .

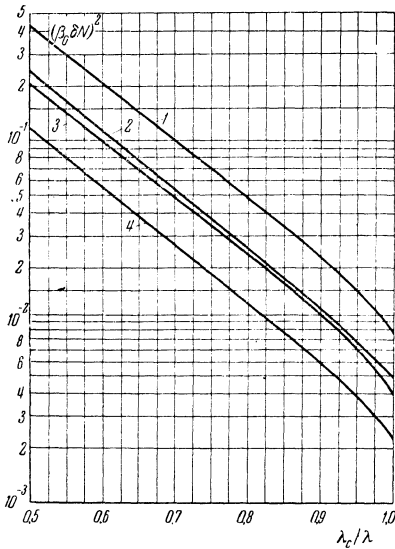

FIG. 6. Theoretical dependence of $(\beta_0 \delta N)^2$ on λ_c/λ for the E layer of the ionosphere with $\xi_0 = 200$ m and $z_0 = 110$ km. Curves 1 and 2 correspond to $z_m = 10$ km and $\lambda_c = 100$ m and 75 m; curves 3 and 4 correspond to $z_m = 20$ km and the same values of λ_c .

The distribution curve of β in Fig. 7 was plotted from extensive diurnal and seasonal measurements for the F_2 region of the ionosphere ($z \sim 250 - 400$ km). These data correspond mainly to conditions under which ω was $(0.8 - 0.9) \omega_c$ and doublets of magnetically split signals were observed, so that the experimental results were of the required clarity. Fig. 7 shows that most frequency $\beta_0 \sim 2 - 4$ so that, taking $\xi \approx 300$ m, we obtain from the curves of Fig. 5

$$\delta N \sim (0.3 - 1) \cdot 10^{-2} \quad (20)$$

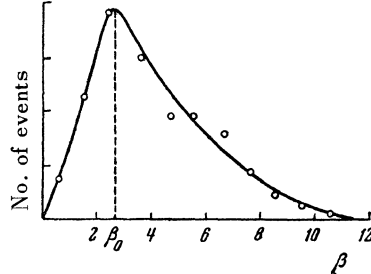

FIG. 7. Distribution of values of the turbidity coefficient β .

and similarly for the E region ($z \sim 100 - 130$ km)

$$\delta N \sim (1 \div 4) \cdot 10^{-2}. \quad (20')$$

(b) Measurements at Very High Frequencies

The experimental results at very high frequencies are collected in Table 1. The measurements were made at noon when the "ionospheric" field component due

to scattering clearly exceeds the "meteoric" component.

From the tabulated data we obtain by means of (19)

$$\xi = 6.2 \text{ m}; 6.9 \text{ m}; 8.0 \text{ m}; 4.8 \text{ m}; 5.6 \text{ m}. \quad (21)$$

The theoretical optimum values of ξ_m are [see (7a)]

$$\xi_m = 10 \text{ m}; 5.8 \text{ m}; 2.7 \text{ m}. \quad (22)$$

Thus from experiment and calculation we obtain as an average

$$\xi \approx 6 \text{ m}. \quad (23)$$

TABLE I. Measurements at various frequencies f and distances d .

$f = 49.8$ Mc (Fig. 16 of Ref. 7)		
$d_1 = 491$ km	$\theta_{1/2} = 19^\circ$	$(P_r)_3 : (P_r)_1 = 4.8'$ and 7.6
$d_2 = 592$ "	$\theta_{2/2} = 16.4^\circ$	$(P_r)_3 : (P_r)_2 = 5.3$
$d_3 = 811$ "	$\theta_{3/2} = 13^\circ$	
$d = 1243$ km (Fig. 19 of Ref. 7)		
$f_1 = 27.775$ Mc	$\lambda_1 = 10.8$ m	$(P_r)_1 : (P_r)_2 = 69.(50)$
$f_2 = 49.8$ "	$\lambda_2 = 6$ m	$(P_r)_2 : (P_r)_3 = 1580.(2240)$
$f_3 = 107.8$ "	$\lambda_3 = 2.78$ m	
$d = 1243$ km (Figs. 8, 9 of Ref. 7)		
$f_1 = 27.775$ Mc	$E = 28$ db (34.5 db)	$(P_r)_1 = 2.7 \times 10^{-13}$ w
$f_2 = 49.8$ "	$E = 17$ " (16 ")	$(P_r)_2 = 2.1 \times 10^{-14}$ "
$f_3 = 107.8$ "	$E = 7$ " (-12.15 "')	$(P_r)_3 = 2.1 \times 10^{-16}$ "

(In db above $1 \mu V$; $1 \mu V$ corresponds to 4.2×10^{-16} w).

Since the scattering of very short waves during the day takes place at $z \approx 80$ km,⁸ our results suggest the presence at this level of inhomogeneous blobs of electrons a few meters in extent, which are able to scatter such wavelengths. If it is assumed, furthermore, on the basis of various experimental findings, that at this altitude $N \approx 5 \times 10^2$ and we select $\Delta z \approx 10$ km, it follows directly from Table 1 [see (18)] that

$$\delta N \sim (0.1 \div 1.3) \cdot 10^{-2}, \quad (24)$$

which is close to the values calculated above for the highest altitudes.

These results are evidently in agreement with the foregoing hypothesis that the principal factor which affects scattering is the size of the inhomogeneities and that a wave "selects" a region containing the optimum size. This may fur-

nish an explanation of the fact that in the experiments with very short waves scattering occurred in a lower part of the ionosphere rather than at $100 - 110$ km, to which height most of the energy was radiated.

If this explanation is not accepted and, as in Ref. 9, we take $\xi \approx 200$ m, we must still account for the fact mentioned above and also explain why very short waves are not scattered mainly at still higher altitudes where the inhomogeneity size is $\xi \sim 200 - 300$ m with the electron concentration increasing by a factor of about 10^3 , so that the scattered energy should increase by 10^6 .*

For the purpose of clearing up these questions it would be particularly interesting to perform similar investigations with short waves, accompanied by measurements of the scattering altitude and by altitude sounding of the ionosphere in a range including low frequencies and providing the needed information concerning $N(z)$. Such complete experiments could, in particular, furnish very important information concerning the relation between inhomogeneity size and altitude.

4. CONCLUSIONS

It is well to take note of a number of relationships observed in the present work as well as of previously known facts which can be of importance for theoretical investigations of the mechanisms involved in the statistical inhomogeneities of the ionosphere.

First, it is well known that from the bottom of the ionosphere ($z \sim 80$ km) to the height of maximum ionization ($z \sim 350 - 400$ km) the electron concentration N changes by a factor of $10^3 - 10^4$, and that the density of neutral particles and the corresponding mean free path changes by $10^5 - 10^6$, while the temperature changes by a factor of 7 to 8. Also, according to the data obtained here the fluctuations of the electron density δN as well as the known values of inhomogeneity size ξ_0 and random velocity v_0 evidently change very little with height.† This is a striking fact which at first glance seems incomprehensible.

Secondly, in vertical sounding of the ionosphere, when the transmitting and receiving points coincide, most of the received field must result from scattering by the largest inhomogeneities. Therefore the most frequent experimental values $\xi \sim 200 - 300$ m for heights of 100 - 300 km and higher must be characteristic of the largest inhomogeneities. In addition, estimates of the sizes of small-scale eddies, plasma wavelengths, and the mean free path lead to the conclusion that inhomogeneity sizes of 200 - 300 m would be "forbidden" above 200 - 250 km, which is also unexpected and difficult to understand.

Further, the velocity u_0 of horizontal drift in the ionosphere between $z \sim 80 - 130$ km and $z \sim 300$ km evidently changes from $u_0 \sim 70$ m/sec to ~ 100 m/sec. The velocity gradients du_0/dz at these altitudes are, respectively, about + 3.4 m/sec per km and + 1 m/sec per km, and if their values were of the same order of magnitude over the entire range of heights, then at $z \sim 300$ km u_0 would be 400 - 500 m/sec or greater, which does not correspond to reality. It is thus suggested that the velocity gradient has the indicated values only in limited altitude ranges, i.e., there are very narrow local regions with active wind development and large gradients together with extensive relatively windless regions, or that the sign of du_0/dz changes with altitude. If such conditions exist in the ionosphere the retardation at the "walls" of these regions could under certain circumstances result in turbulent streams of particles.

If thus appears that at the present time the picture of these effects is complicated and obscure. We still have no theoretical basis for a profound analysis using definite mechanisms. Since, however, there exists a certain tendency, just as in the case of other similar phenomena, to ascribe these effects to turbulence, we shall briefly summarize estimates based on formulas derived in the theory of turbulence from similarity considerations.¹²

It must first of all be understood that the utilization of formulas from the theory of turbulence for the

*We note here that in Refs. 9 and 10, in addition to the unjustified choice $\xi \sim 200$ m, values of $N \sim 2 - 5 \times 10^4$ are used, which correspond to the electron concentration of the E or sporadic E layer, although the experiments themselves yield values of Z below the heights of E and E_{sporadic} . It is also appropriate to point out that when ξ is determined from the experimental data by the method described in this section and the Booker-Gordon formula⁴, imaginary values of ξ are obtained. We recall also that the formula for the autocorrelation coefficient $\rho(r) \sim e^{-r/\xi}$ which is the basis for the deduction of σ in Refs. 3 and 4 is known to lead to fundamental contradictions because of the finite value of the derivative $d\rho/dr$ at $r = 0$, with a corresponding discontinuity of the dielectric constant at this point.

†It must be remembered that in all of the papers in which ξ_0 , v_0 , and β_0 were determined the altitude dependence of wavelength in the ionosphere was not taken into account. A proper review of these values would require some modification of the familiar methods of determining these quantities. It is not known what changes would result. The author is now investigating these questions.

purpose of calculating the properties of inhomogeneous blobs of electrons is in itself not legitimate. These formulas were derived for media consisting of neutral particles so that without a special analysis they can certainly not be applied, especially to calculations for a highly rarefied plasma. This problem can only be solved by a study of electron motion in a turbulent flow; thus far this has not been done.

It is known that the microscale L_s and velocity change Δu_s of eddies are given by

$$L_s \approx L_0 / \text{Re}^{-1/4}, \quad \Delta u_s \approx \Delta u_0 / \text{Re}^{-1/4}, \quad (25)$$

where $\text{Re} = \Delta u_0 L_0 / \nu$ is the Reynolds number, L_0 is the thickness and Δu_0 is the change in laminar velocity of the turbulent flow, and ν is the kinematic viscosity.

We can also add the formula

$$\overline{(\delta N_s)^2} \approx \Delta u_s^4 / v_m^2, \quad (26)$$

which is obtained for homogeneous isotropic turbulent flow based on

$$\Delta p_s \approx \rho (\Delta u_s)^2, \quad (27)$$

where Δp_s represents the pressure fluctuation of the inhomogeneities, ρ is the density of the medium and v_m^2 is the root mean square particle velocity; it is assumed that $\Delta p_s / p \sim \Delta \rho_s / \rho \sim \Delta N_s / N = \delta N_s$.

We now assume that L_0 is commensurate with the thicknesses of the layers and that Δu_0 has two possible values: the first of these values corresponds to the velocity u_0 of horizontal drift, and the second to the assumed change in u_0 given by $\Delta u_0 = (du_0/dz)\Delta z$. Then from (25) and (26) there are obtained the values of L_s , Δu_s and δN_s listed in Table 2.

Table 2 shows, first, that the Reynolds number is generally quite large; this is usually a criterion of turbulence. But it is not known whether this criterion is valid for the ionosphere and what is "large" in this instance. It is therefore hardly possible to draw any conclusions from these values.

Secondly, up to the height $z \approx 200$ km the values of L_s and Δu_s corresponding to the minimum (!) size of small-scale inhomogeneities are close to the experimental values of ξ_0 and v_0 , but at greater heights there is strong divergence.

And, finally, the electron density fluctuations $(\delta N_s)^2$ are everywhere approximately $10^3 - 10^4$ times smaller than the experimental values obtained above. If, however, it is assumed that the change of electron density $|\Delta N_s| \sim |dN/dz| L_s$, thus resulting from the altitude gradient of the electron density, there is obtained for all heights

$$(\delta N)_s \equiv |\Delta N_s| / N \sim (1 \div 3) 10^{-3},$$

which is in close agreement with the results obtained above.

It must again be emphasized that although estimates of the ionospheric parameters based on turbulence concepts are in some instances consistent with other data, any conclusions based on this fact would be premature.

TABLE II

z, km	$\sqrt{u^2}, \frac{\text{m}}{\text{sec}}$	L_0, km	$\Delta u_0, \frac{\text{m}}{\text{sec}}$	Re	$\Delta u_s, \frac{\text{m}}{\text{sec}}$	L_s, m	$\delta N_s \cdot 10^4$
80	400	5	70	$4 \cdot 10^5$	3.5	4	6
	400	5	18	$2 \cdot 10^3$	2.6	15	0.8
100	400	5	70	$2 \cdot 10^4$	7	5	3
	400	5	18	10^2	5	140	4
200	1000	30	100	50—400	60	160—1600	3
	1000	30	30	15	15	$4 \cdot 10^3$	2
300	1300	100	200	10—80	70—100	$(4-18) \cdot 10^3$	40
	1300	100	100	5	70	$30 \cdot 10^3$	90

¹Ia. L. Al'pert, Usp. fiz. nauk **49**, 49 (1953).

²I. A. Ratcliffe, Reports on Progress in Physics **19**, 188 (1956).

³C. L. Pekeris, Phys. Rev. **71**, 268 (1947).

⁴H. G. Booker and W. E. Gordon, Proc. Inst. Radio Engrs. **38**, 401 (1950).

⁵Booker, Ratcliffe, and Shinn, Trans. Roy. Soc. (London) **242**, 579 (1950).

⁶Ia. L. Al'pert and A. A. Ainberg, J. Exptl. Theoret. Phys. (U.S.S.R.) **21**, 389 (1951).

⁷Bailey, Bateman, and Kirby, Proc. Inst. Radio Engrs **43**, 1181 (1955).

⁸V. C. Pineo, J. Geophys. Res. **61**, 165 (1956).

⁹D. K. Bailey et al., Phys. Rev. **86**, 141 (1952).

¹⁰F. Villars and V. F. Weisskopf, Phys. Rev. **94**, 232 (1954); Proc. Inst. Radio Engrs **43**, 1232 (1955).

¹¹Ia. L. Al'pert, Проблемы современной физики, (Problems of Mod. Phys.) **7**, 5 (1955).

¹²L. D. Landau and E. M. Lifshitz, Механика сплошных сред, (Mechanics of Continuous Media) (GTTI, 1954).