

SOVIET PHYSICS

JETP

A translation of the Journal of Experimental and Theoretical Physics of the USSR.

SOVIET PHYSICS JETP

VOL. 35(8) NO. 5, pp. 743-921

MAY, 1959

WORK OF FORMATION OF AN ELASTIC TWIN IN CALCITE

I. V. OBRIMOV and V. I. STARTSEV

Khar'kov Institute for Mechanization of Agriculture; Moscow Engineering-Physical Institute

Submitted to JETP editor June 7, 1958

J. Exptl. Theoret. Phys. (U.S.S.R.) **35**, 1065-1073 (November, 1958)

The linear dimensions and shape of an elastic twin in calcite, produced under the action of a concentrated load, have been measured. The linear dimensions are proportional to the load, and the area of the twin surface is proportional to the work done by the deforming stress.

1. STATEMENT OF THE PROBLEM

CRYSTALS of the mineral calcite belong to the trigonal class. They possess a highly perfected cleavage. A calcite crystal bounded by cleavage planes has the shape of a rhombohedron whose three obtuse angles about the three-fold symmetry axis are equal to $101^{\circ}52'$ (Fig. 1). A calcite crystal is shown in profile in Fig. 2. It has long been known (even in the days of Huygens¹) that under a tangential stress, as indicated in Figs. 1 and 2, a calcite crystal shifts into a twinned configuration (see Figs. 2 and 3). The plane EGHK is the boundary separating the two crystals, parent and twin. The latter is the mirror image of the parent crystal in the plane EGHK. The angle AEA_1 (Fig. 2) is $38^{\circ}04'$; half of this angle is equal to $19^{\circ}02'$.

Kelvin has suggested that mechanical twinning proceeds as follows (see Fig. 2): The crystal has two states of stable equilibrium. At first, under the action of the tangential stress, the angle A' approaches a right angle, then attains the value 90° , after which the crystal switches over into the symmetrical twinned configuration.

Voigt² measured the tangential stress at which the twinning transformation occurs in a calcite crystal and obtained the figures 3200 and 7500 g/mm²; these are very low values, which give angle changes of $4.4'$ for the first figure and $10.4'$ for the second, and for which the deformation is

FIG. 1. A rhombohedron of calcite, bounded by cleavage planes.

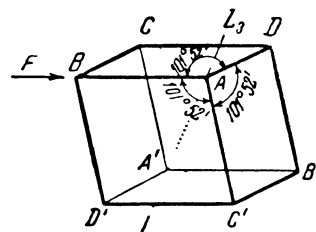

FIG. 2. Calcite rhombohedron, profile view. The upper part of the crystal is brought to the twinned configuration by the load F; GE is the twinning plane, A_1 is the new position of point A after twinning.

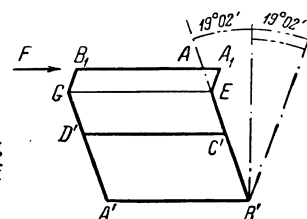
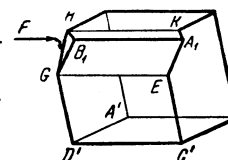

FIG. 3. The twinned calcite crystal. GHKE is the twinning plane, A_1B_1 is the new position of the edge AB of Fig. 1 after twinning.



within the limits of Hooke's law. This fact is common to all types of crystal rupture: rupture occurs at stresses that are several orders lower than those which follows from any theory.

As is known, Garber^{1,3} found a way out of this contradiction. The point is that mechanical twin-

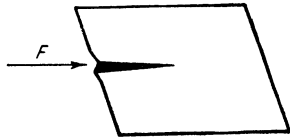

FIG. 4. Elastic twin (according to Garber¹).

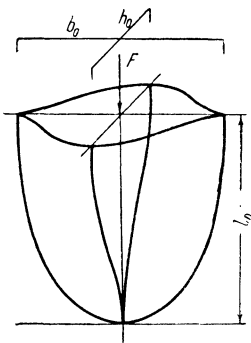

FIG. 5. Diagram of an elastic twin. l – coordinate in the direction of the length, l_0 – total length of the twin, $b/2$ – coordinate in the direction of the breadth, b_0 – total width of the twin, $h/2$ – coordinate in the direction of the thickness, h_0 – maximum thickness of the twin.

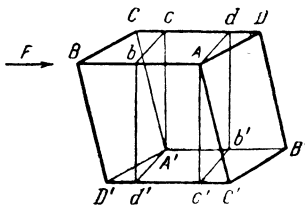

FIG. 6. Preparation of the rhombohedron of calcite, depicted in Fig. 1, for the experiment.

ning in calcite proceeds not according to the scheme of Fig. 2, but in the following manner (Fig. 4): At first, at the point of application of the force F , a twin lamella is formed, whose length l_0 , breadth b_0 and thickness h_0 grow (or contract) with increasing (or decreasing) load F . If the load F is removed, then the twin lamella disappears entirely. The shape of an elastic twin, obtained on the basis of the present work, is shown schematically in Fig. 5, in which the scale of thickness is taken three orders larger than the scale of l and b . This formation, called elastic twin, becomes under a sufficiently large applied load a residual twin – a twin lamella, which fills the entire crystal and which, upon further increase of the load F , grows in breadth in an irreversible manner. Upon removal of the load, h and b do not decrease. Garber⁴ measured the tangential stress necessary to increase the thickness of a residual twin lamella and obtained values from 50 to 400 g/mm² (reference 5). As to any measured values that characterize elastic twins, we have no corresponding figures. The object of the present work is to obtain the values that characterize an elastic twin.

2. ARRANGEMENT AND OBJECT OF THE EXPERIMENT

We prepared a calcite crystal for experiment in the following manner:

FIG. 7. Further preparation of the calcite prism $bcA'd' - Adb'c'$, depicted in Fig. 6, for the experiment.

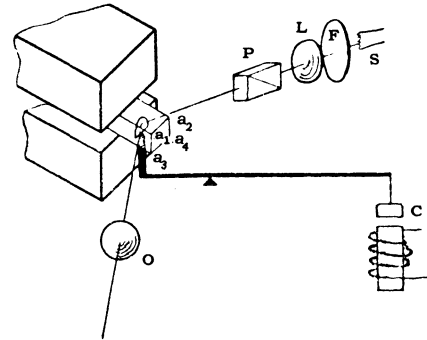
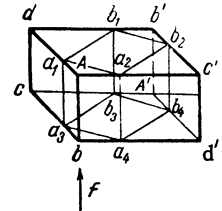

FIG. 8. Diagram of the apparatus. The crystal $a_1a_2a_3a_4$ is held in the vise. A piece of soft iron C is attracted to the electromagnet and through the lever provides a localized load on the calcite crystal. S) light source, F) filter, L) lens, P) polarizer, O) objective which projects the image of the twin onto a photographic plate.

(1) The facets $CBD'A'$ and $ADB'C'$ were cut away with a fine cutter on a milling machine to form the two faces $cbd'A'$ and $dAb'c'$, perpendicular to the edge BA (Fig. 6). These faces were ground and polished. (After further working, the crystal was clamped with the face $dAb'c'$ on the underside of the upper stage of a press, the pressure being exerted by balls of various diameters on the lower face $cbd'A'$.)

(2) The dihedral corners $b'dA$ and $b'c'A$ were cut off by planes parallel to the edges $c'd'$ and cd and perpendicular to the major diagonal dc' (Fig. 7). These planes too were ground and polished. The crystal was illuminated through one of these and the elastic twin was observed through the other. Finally, the dihedral corners Ab and $A'b'$ (Fig. 7) were cut away. The parallelepiped $a_1b_1b_2a_2a_3b_3b_4a_4$ obtained became the object of further experiments. The specimen was clamped in a vise so that the face $a_1a_2a_3a_4$ was on the bottom (Fig. 8). The pressure was produced by a punch, the end of which was rounded off in the form of a hemisphere. The pressure was brought to bear by a lever of the first order. The force on the end of the lever was produced by the soft iron core C , which was drawn into a solenoid. The force was determined from the current, and in reality from the position of the slide of the rheostat that regulated the current. The twinned petal was illuminated by a beam of parallel light (an automobile lamp at the principal

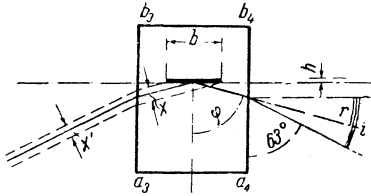

FIG. 9. Construction by means of which Eq. (5) is demonstrated. a_3, b_3, a_4, b_4 is the calcite crystal and the heavy segment is the twin lamella, b) its breadth, h) its thickness, i) the angle of incidence, r) the angle of refraction, φ) the angle of incidence of the beam on the twin lamella; $\varphi = 90^\circ - r$, X') the apparent breadth of the twin.

focus of the lens L with principal focal distance $f \sim 20$ cm.). The light passed through an interference filter F , which transmitted the wavelength $\lambda = 5.88 \times 10^{-5}$ cm; the angle of incidence was 27° . Experiment and calculations have shown⁶ that with normal incidence of light on a twin lamella, there must be no reflected light observed at all. The optimum reflection is at the 27° angle of incidence chosen by us. The image of the elastic twin was projected onto a photographic plate by means of the objective lens of a binocular microscope (or examined directly by eye). On account of the double refraction in calcite, two images of the petal were obtained. The extraordinary-beam image was eliminated by the Nicol prism P , and observations were conducted with the ordinary beam. We have assumed that the indices of refraction μ_0 and μ_e for the ordinary and extraordinary beams respectively are equal to:⁷

$$\mu_0 = 1.658; \mu_e = 1.486. \quad (1)$$

With the angle of incidence at 27° , the angle of refraction for the ordinary beam is $15^\circ 53'$ and the beam is incident on the twin at the angle φ (Fig. 9).

$$b_0 = X' 2\mu_0 \cos r / \sin 2i = 3.945X', \quad (2)$$

The image of the twin was covered with interference fringes, through which it was possible to determine the thickness of the twin according to the formula

$$2\mu h \cos \psi = n\lambda, \quad (3)$$

where h is the thickness of the twin, ψ the angle of refraction, μ the index of refraction of the twin, n the number of the interference fringe, and λ the wavelength of the light, equal to 5.88×10^{-5} cm.

With regard to the quantities μ and ψ , it must be borne in mind that inside the twin the position of the optical axis is different than in the parent crystal and the beam which is extraordinary inside the twin undergoes total internal reflection. Thus, inside the twin we have $\mu = \mu_0$; ψ is equal to the

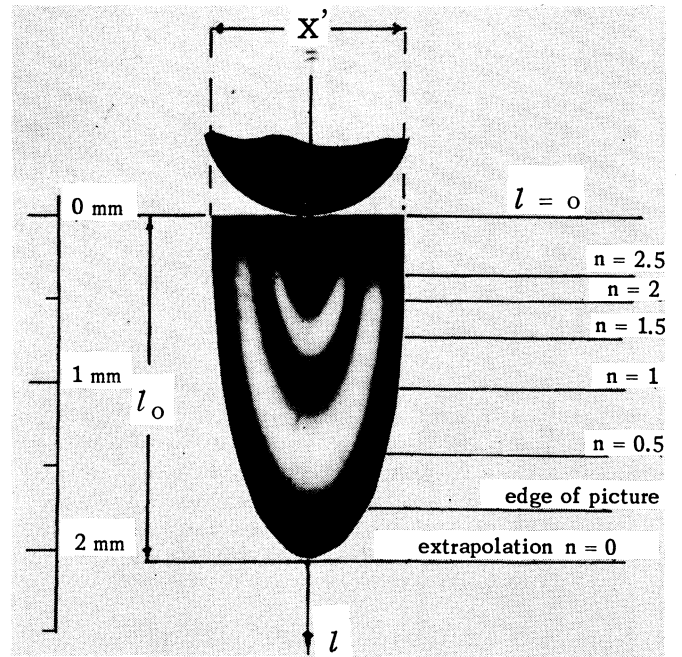

FIG. 10. Photograph of elastic twin 8B-3. The scale of measurement is shown at the left. Designation is given at the right above the lines. The figure has been cut out of a photograph, and its external contour has been extrapolated. Above, the spherical tip of the steel plunger is indicated.

angle of incidence, and Eq. (3) yields:

$$h = n \cdot 5.88 \cdot 10^{-5} / 1.658 \cdot 0.2737 = n \cdot 1.30 \cdot 10^{-4} \text{ cm}, \quad (4)$$

where n is the number of the interference fringe.

The shape of elastic twin 8B-3 is shown in Fig. 10. The length of the twin l_0 is given by direct measurement. The width of the twin b_0 is seen in projection. To obtain the true width of the twin, it is necessary to multiply its apparent width (X' in Fig. 10) by the amount indicated in the following formula:

$$b_0 = X' 2\mu_0 \cos r / \sin 2i = 3.945X', \quad (5)$$

which is clear from Fig. 9, if Eqs. (1), (2) and (4) are taken into account. The thickness of the twin is given by Eq. (4).

3. SHAPE AND DIMENSIONS OF AN ELASTIC TWIN

From Fig. 10 it is seen that the length l_0 and breadth b_0 of an elastic twin are in essence quantities of the same order, while its thickness is three orders smaller. Schematically, the shape of the twin is given in Fig. 5, in which the scale of thickness is magnified 1000 times. Figure 11 shows two cross sections of elastic twin 8B-3; l_0 and b_0 are given in millimeters and the thickness h_0 in microns. The results of measurement of twin 8B-3

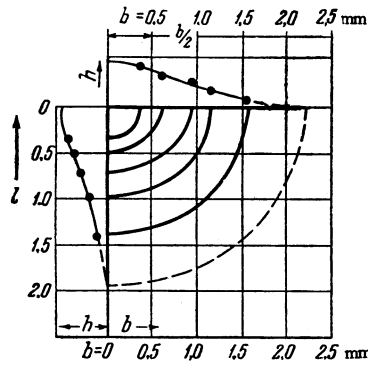

FIG. 11. Results of measurement of twin 8B-3. The solid lines are lines for which $n = 2.5, 2.0, 1.5, 1.0, 0.5$, for the right-hand half of the twin. The line $n = 0$ was obtained by extrapolation, and is dashed. Above and to the left, cross sections through the twin are shown in a different scale than that used in the plan drawing of the twin. The solid line shows the interpolated contour and the dashed line the extrapolated. $h = 2.0 \times 10^{-3}$ mm.

are presented in Table I. In Fig. 11 there is an indeterminacy which always occurs in the measurement of small thicknesses by an interference method, namely in gaging the point where $n = 0$. We did this by a very unreliable method for want of a better one. Experience in the investigation of optical contacts⁸ has shown that the location of the spot with thickness $h = 0$ can be determined as follows: The distance from the middle of the band $n = 0.5$ to the "border" (a very indefinite concept) of the interference picture is measured. The vanishing point of the interference is assumed to be at a like distance beyond the "border" of the interference picture.

We possessed three calcite crystals, Nos. 6, 7, and 8. Crystals 6 and 7, were colorless, cleaved easily upon twinning by Baumgauer's method, and had mosaic cleavage planes. Crystal No. 8 was of light yellow color (probably due to $FeCO_3$ dissolved in it) was very perfect and twinned softly and easily. The results of measurements anal-

TABLE I. Dimensions of twin 8B-3:
 $l_0 = 1.95$ mm; $b_0 = 2.44$ mm;
 $h_0 = 1.95 \times 10^{-4}$ cm. Load $F = 2.58$ kg.

n	X'	l , mm	b , mm	$h \cdot 10^{-4}$, cm
3.0	0	0	0	$h_0 = 1.95$
2.5	0.11	0.34	0.45	1.63
2.0	0.15	0.48	0.60	1.30
1.5	0.23	0.72	0.93	0.98
1.0	0.29	0.98	1.14	0.65
0.5	0.36	1.40	1.47	0.33
0*	0.52*	$l_0 = 1.95^*$	$b_0 = 2.44^*$	0*

*Extrapolated

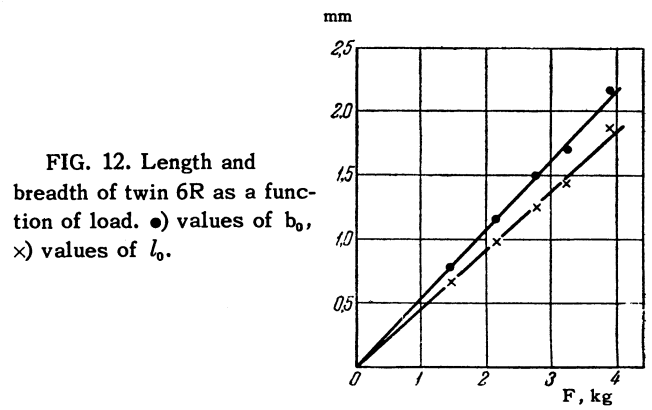

FIG. 12. Length and breadth of twin 6R as a function of load. ●) values of b_0 , ×) values of l_0 .

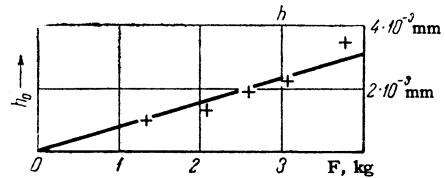

FIG. 13. Thickness h_0 of twin 8B as a function the load.

gous to those presented in Table I are given in Figs. 12 and 13. In Fig. 12 the load F is plotted along the abscissa while the ordinates of b_0 are marked by dots and those of l_0 by crosses. It is seen that the length and breadth of an elastic twin are proportional to the load as has been noted by Garber.¹ In Fig. 13 the value of h is given as a function of F . This last quantity is also seen to be proportional to the load. Thus, under the influence of a concentrated load, an elastic twin changes its dimensions but retains its shape.

Figures 14 and 15 show the results of measurements made at different points of crystals Nos. 6,

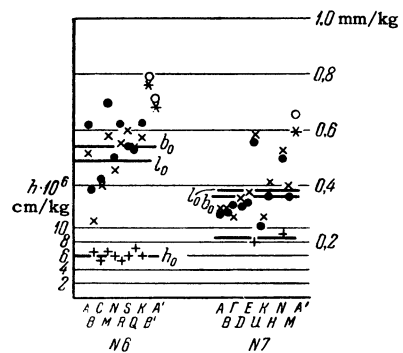

FIG. 14. Results of experiments on crystals No. 6 and 7. Values of the quantities dl_0/df and db_0/dF (in mm/kg) and values of dh_0/dF (in $cm/kg \times 10^6$) are plotted along the ordinate. The average value of each of these quantities is given as a heavy line for each of the specimens. Measurements for a single experiment are plotted on one vertical, below which the number for the experiment is denoted by a letter. ○) breadth b_0 , 1 mm diameter ball; ●) breadth b_0 , 1.8 mm diameter ball; *) length l_0 , 1 mm diameter ball; ×) length l_0 , 1.8 mm diameter ball; +) thickness h_0 (in the other scale).

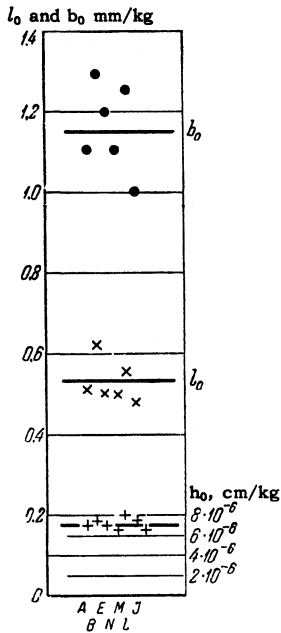

FIG. 15. The same as Fig. 14, but for crystal No. 8. Ball diameter 1.8 mm.

7, and 8. The abscissa represents the number of the experiment, and the ordinate the values of l_0 , b_0 , and h_0 which the twinned petal assumes under an absolute load of 1 kg. Using these data and also the data of Figs. 12 and 13, we can measure the work of the force F . As an example, we have from Table I a load F of 2.58 kg. = 2.54×10^6 dynes. The thickness of the twin is 1.95×10^{-4} cm. As is evident from Fig. 16, the distance over which the plunger is displaced is

$$bb_1 = h \cdot 2 \tan 19^\circ = 0.688 \cdot 1.95 \cdot 10^{-4} \text{ cm} = 1.34 \cdot 10^{-4} \text{ cm}.$$

Hence, the work done by the plunger is equal to

$$A = \frac{1}{2} F \cdot \bar{bb}_1 = 340 \text{ ergs}.$$

This energy can go either into production of elastic tension in the elastic twin and its surroundings, or into formation of the surface of the twin. The area of our twin is $\pi l_0 b_0 / 2$, and its two surfaces amount to $S = \pi l_0 b_0 = 1.42 \times 10^{-1} \text{ cm}^2$:

$$A/s = 2400 \text{ ergs/cm}^2.$$

The corresponding work of formation of one surface comes to 1200 ergs/cm^2 . We can show that the elastic energy of the deformed twin and its surroundings is two orders smaller than this value.

Let us make a very rough calculation: We replace the twinned petal by a platelet having the shape of a parallelepiped of height l_0 , breadth $2b_0$ and thickness h_0 . Under the action of the load F , the height is shortened by an amount Δl , where $\Delta l = l_0 F / E b_0 h_0$, and E is Young's modulus. The work of compression of such a parallelepiped is equal to $\Delta l^2 E b_0 h_0 / 2 l_0$. In place of $1/E$ we use the coefficient s_{11} . For calcite, $s_{11} = 11.3 \times 10^{-13}$ in the cgs system. As also in the foregoing exam-

FIG. 16. Illustration for the calculation of the work done by the force F .

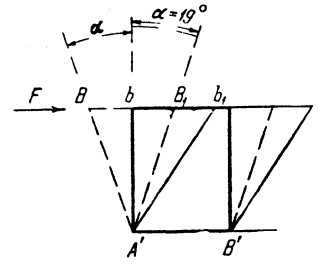
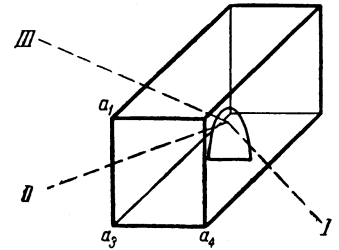

FIG. 17. Observation of cracks associated with an elastic twin. I) incident beam of light, II) beam of light reflected from the plane of the twin, III) beam of light reflected from the cracks.



ple, having taken $\Delta l = b l_1 = 1.34 \times 10^{-4} \text{ cm}$, $b_0 = 2.44 \times 10^{-1} \text{ cm}$, $l_0 = 1.95 \times 10^{-1} \text{ cm}$, and $h = 1.95 \times 10^{-4} \text{ cm}$, we find that the work of elastic compression is equal in all to 2.9 ergs instead of 340 ergs. Thus it is found that the entire work of the force F is in the surface layer of the twin.

It is necessary to note that this energy is very large (the surface tension of water is equal to 70 ergs/cm^2). If one imagines the boundary of the twin and parent crystal as closely contiguous, then such values of surface energy seem impossible. This value does appear possible, however, if one imagines that the boundary of the twin and parent crystal is stepped and that these little steps constitute a break in the cleavage plane. It can happen that one of the faces of the elastic twin is a crystallographic twin plane in which case the energy calculated by us applies to one of the surfaces of the twin. It can happen that both surfaces are not crystallographic planes and then the energy we calculated applies to both sides of the twin.

Direct observation confirms that near the surface of an elastic twin there is a break of continuity. Specifically, if we illuminate the twin, as usual, with beam I (Fig. 17) and place our eye or the objective of a microscope in the reflected beam II, we see the interference pattern shown in Fig. 10. If, however, we sight in the direction III, then we again see light reflected from the elastic twin, which indicates the presence of a crack or cracks close to the surface of the elastic twin. We are planning a detailed investigation of this phenomenon.

4. BREAKDOWN OF CRYSTALS

There are two types of crystal breakdown: (1) rupture along a cleavage plane with a break in continuity; (2) various types of "slip," to which

TABLE II. The work which goes into the formation of 1 cm² of surface of an elastic twin

Twin No.	Work (Ergs/cm ²)	Twin No.	Work (Ergs/cm ²)
6K	3720	8A	2670
6S	5160	8B	2400
7U	4450	8L	2890
7N	6400	8β	2400

mechanical twinning is also related.

As far as rupture along a cleavage plane is concerned, it appears that if the rupture stress is taken as a measure of the stability of a crystal, no fixed numbers are obtained and the stability depends on how the rupture stress is applied. If, however, the specific work necessary for the formation of a new surface is taken as the measure of stability, this work does not depend on how the rupture proceeds and it can be called an invariant of the breakdown.

At first glance, the breakdown of a crystal by rupture and by slip have nothing in common with each other, but more and more observations indicate that, in order for the shearing action to become possible, a break in continuity is necessary and rupture is essential. In fact, in the case of optical contact of two polished optical surfaces,⁸ slip of these surfaces is not possible: it is necessary for them to first break away from one another, after which they can shift. This pertains to all forms of optical contact.⁹ In reference 10 it is shown that the initial stage of plastic deformation in rock salt is by ultramicroscopic cracks which manifest themselves as Tyndall cones.⁴ In numerous papers by Likhtman and Rebinder (e.g., reference 11), the effect of surface-active substances on plastic deformation is demonstrated. It has been directly demonstrated how surface-active substances affect the formation of cracks and how cracks initiate shears.³ Finally, in the present work it is shown that the start of mechanical twinning in calcite is the formation of a new surface and that the specific work for the formation of this surface is an invariant quantity, characteristic of the material.*

5. CERTAIN DETAILS OF THE PHENOMENON

It should be noted that not all the experiments go as smoothly as described in the preceding sections. Cases occur where the length of the twin

*The major role which cracks in the cleavage plane play in plastic slip and twinning has already been indicated repeatedly by R. I. Garber in earlier communications.

depends linearly on the load, but is not proportional to the load, i.e., an impression is gained that the elastic twin is formed starting with a certain requisite initial load.

In some cases application of a certain load produces no twin at first, but the twin is produced after the crystal has remained under load for a while.

We feel that in our experiments it is surprising and noteworthy that in the breakdown of a crystal it is possible to obtain certain constants which we call invariants. In the case of an elastic twin, such invariants are the shape of the twin under localized load and the work of formation of the surface.

Finally, the work of formation of the twin is itself very large. In calculating the work of formation of the twin, we regarded the force F as applied to the border of the twin. It would be more correct to assume that the force is applied to the center of the twin. Then all the numbers given in Figs. 14 and 15 must be reduced by a factor of two, and with them also the amounts of work presented in Table II. A direct measurement of the work must settle this question.

¹R. I. Garber, Dissertation, Alma Ata, 1942.

²W. Voigt, Wiedem. Ann. **67**, 201 (1899).

³R. I. Garber, J. Exptl. Theoret. Phys. (U.S.S.R.) **17**, 1 (1947).

⁴R. I. Garber, Dokl. Akad. Nauk SSSR **57**, 555 (1947).

⁵R. I. Garber, J. Exptl. Theoret. Phys. (U.S.S.R.) **16**, 923 (1946).

⁶G. B. Rais, Dokl. Akad. Nauk SSSR **106**, 841 (1956).

⁷Ia. G. Dorfman and S. E. Frish, Сб. физических констант (Collection of Physical Constants), ONTI (1937).

⁸I. V. Obreimov and E. S. Trekhov, J. Exptl. Theoret. Phys. (U.S.S.R.) **32**, 185 (1957), Soviet Phys. JETP **5**, 235 (1957).

⁹J. W. Obreimoff, Proc. Roy. Soc. A**127**, 290 (1930).

¹⁰Garber, Obreimov, and Poliakov, Dokl. Akad. Nauk SSSR **108**, 425 (1956), Soviet Phys. "Doklady" **1**, 314 (1956).

¹¹Rebinder, Likhtman and Kachanova, Dokl. Akad. Nauk SSSR **111**, 1278 (1956).