

*EMITTERS OF ALPHA PARTICLES WITH ENERGIES OF ABOUT 9 AND 12 Mev IN THE Po—Ra REGION**

V. A. KARNAUKHOV, V. I. KHALIZEV, and G. N. FLEROV

Submitted to JETP editor June 22, 1959

J. Exptl. Theoret. Phys. (U.S.S.R.) **37**, 1266-1272 (November, 1959)

Lead was irradiated with accelerated oxygen and carbon ions. Isotopes emitting 11.8 ± 0.4 and 9.0 ± 0.3 Mev particles with half-lives of approximately one minute and 35 ± 10 seconds respectively were detected among the reaction products. Certain ideas are advanced concerning the identification of these isotopes.

It has been noted many times that the use of accelerated heavy ions offers broad possibilities of obtaining new neutron-deficit isotopes of practically all elements.^{2,3} For elements in the beginning and middle of the periodic table it is evidently possible to obtain the lightest isotopes, i.e., those near the boundary of the region of radioactive nuclei. Heavy ions are a particularly convenient means of obtaining and investigating the properties of light isotopes of elements from At to Ac. Many of these nuclei are difficult to prepare with the aid of beams of light particles (nucleons, deuterons, or α particles), since they do not have sufficiently stable isotopes capable of serving as targets. When heavy ions are used this difficulty is eliminated, for the target used can be an element (bismuth, lead, mercury, etc.) that differs greatly in atomic number from the final nucleus.

In the present investigation we studied unknown α emitters among the products of reactions caused by accelerated oxygen and carbon ions in lead.

1. EXPERIMENTAL PROCEDURE

The experiments were carried out with the 150-cm cyclotron of the U.S.S.R. Academy of Sciences. We had at our disposal intense beams of quintuply-charged ions of O^{16} and quadruply-charged ions of C^{12} and C^{13} , accelerated to 102.77 and 83 Mev respectively. To avoid overheating of the target, the particle beam intensity was kept below 0.2 or 0.3 μ a. The irradiation took place inside the cyclotron chamber. The short-lived α -active reaction products were investigated with special apparatus shown schematically in Fig. 1, making use of the method of gathering recoil nuclei, as described in references 4 and 5. This method enabled us to use the same target in various experiments, which facili-

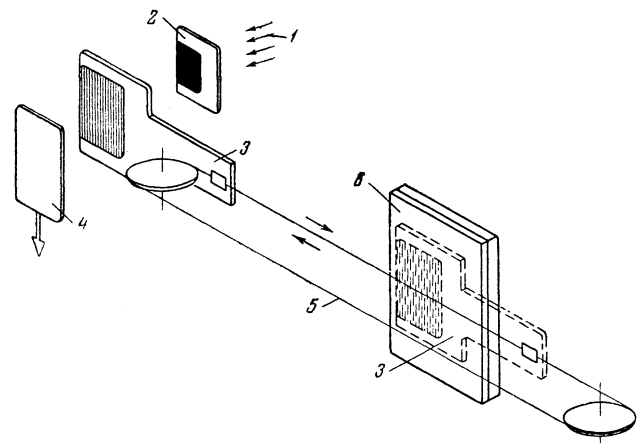

FIG. 1. Arrangement for the registration of α decay of the reaction products

tated considerably the comparison of the results. The ion beam 1 was incident on a lead target 2, deposited on an aluminum foil ($5 - 6 \mu$). The reaction products, with large momenta, were emitted from the target and struck a thin ($\sim 2 \mu$) aluminum receiver 3. After passing through the target and receiver, the bombarding particles were stopped by the current collector 4. The collector was connected to the current meter, so that the intensity of the beam could be monitored during the irradiation process and the total ion current through the target could be measured. The receiver was periodically moved, with the aid of kapron thread 5, two meters away from the target and placed near photographic plate 6, which registered the α decay of the reaction products. All these devices were placed in a vacuum container connected to the cyclotron chamber. The kapron thread was driven by an electric motor through a special seal, since the motor was outside the vacuum system. To estimate the half-lives of the nuclei, provision was made for measuring the times t_1 , t_2 , and t_3 during which the receiver was under

*A brief report of the results of the present investigation is contained in a paper by G. N. Flerov.¹

the target, near the emulsion, and in motion from the target to the emulsion, respectively. The time could be measured over a wide range. In our experiments the first two time intervals were chosen to be equal to each other and could be set at 10, 25, 50, 100 and 250 seconds. The value of t_3 could be set at 3, 10, 50, 100 and 250 seconds. In all the experiments the receiver moved from the photographic plate to the target within 3–5 seconds. Thus, the apparatus used was suitable for the investigation of α decay of nuclei with lifetimes from approximately one second and above. An electronic time relay was used to set the selected operating mode of the apparatus.

The lead targets were deposited on aluminum foil by precipitation from an aqueous solution of $\text{Pb}(\text{NO}_3)_2$ with addition of a certain amount of tetraethylene glycol.⁶ The solution was dried for 5–6 hours under a lamp (500 watts) with gradual increasing of heating, after which the layer was roasted at approximately 500° , causing the lead nitrate to change to the lower oxide form. The targets thus obtained were sufficiently homogeneous and strong. The target thickness was 200–300 $\mu\text{g}/\text{cm}^2$. This thickness is evidently optimal when the recoil-nuclei gathering method is used. In the experiments described below we used targets of natural lead and targets containing essentially the isotopes Pb^{208} and Pb^{207} . The isotopic composition of the substance in the latter two cases is given in Table I.

TABLE I

Target	Isotopic composition, percent			
	204	206	207	208
Pb^{208}	0.1	0.1	0.6	99.3
Pb^{207}	0.1	0.1	97.4	2.6

We used NIKFI-T1 emulsions to register the α decay of the reaction products. These emulsions have good discrimination for α -particle and proton tracks and have low sensitivity to β and γ radiation, so that they could be used in the direct vicinity of the cyclotron for sufficiently long exposures.

II. RESULTS OF THE EXPERIMENTS

1. Experiments on Irradiation of Lead with O^{16} Ions

a) Figure 2 shows the α -particle spectrum obtained by irradiating a target of natural lead with O^{16} ions of ~ 97 Mev. In this experiment, $t_1 = t_2 = 10$ sec and $t_3 = 3$ sec. The spectrum was plotted after scanning a small part of the photographic plate.

Figure 3 shows the "hard" part of the α -particle spectrum, observed by irradiating lead with oxygen. This spectrum was obtained by selective scanning of photographic plates obtained in several experiments. For a better energy resolution we selected only the α -particle tracks that entered the emulsion at dip angles from 15 to 45° . The abscissas represent the ranges of the α particles in the emulsion and the corresponding particle energies. In the calculation of the α -particle energy we took into consideration the fact that the nuclei — the reaction products due to a certain "recoil" momentum — are distributed in depth in the receiver.

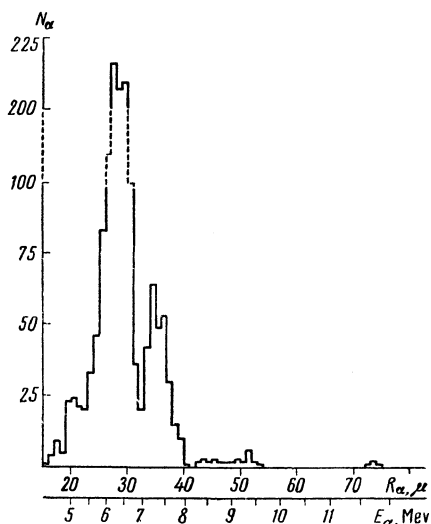

FIG. 2. Energy spectrum of α particles obtained by irradiating lead with oxygen ions.

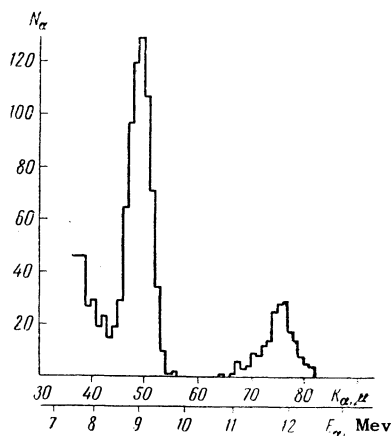

FIG. 3. α -particle spectrum, obtained by irradiating lead with oxygen.

Owing to the slowing down of the particle as it is scattered from the receiver, the measured energy is found to be less than the true one by an average of approximately 100 keV (experimental estimate).

The first to attract attention in the examination of the spectrum are the two groups of α particles,

one with a maximum at 9.0 ± 0.3 Mev and the second with a maximum at 11.8 ± 0.4 Mev. We note that the energy resolution of the method employed is not so great as to permit stating with assurance that each of these α -particle groups is connected with a single monochromatic line. The appearance of such radiation in our experiments is a somewhat unusual fact, since as a rule in the Po — Th region the lifetimes of α -active nuclei with decay energies exceeding 8 Mev is very short.

Another interesting fact is the magnitude of the energy of the second α -particle group — 11.8 Mev. Not in one case of the decay of the heretofore known radioactive nuclei were α particles of so high an energy registered. In the spectrum shown in Fig. 2, the most intense are the groups of α particles whose maxima lie near 6.2 and 7.3 Mev.

After extracting the target from the cyclotron, the half-life of the α emitter that produced the first group of particles was measured with an ionization chamber. This value was found to be approximately 25 minutes. In all probability this group is due to Em^{212} , produced in reactions of the type $\text{Pb}^{207-208}(\text{O}^{16}, \alpha 3 \text{ or } 4n)(x = 0 \text{ to } 2)$.

The bulk of the α particles comprising the group near 7.3 Mev is obviously due to decay of an isotope with an approximate half-life of one minute.

b) The experiments described below were aimed essentially at an investigation of the properties and mechanism of formation of α emitters the decay of which leads to particles with energies ~ 11.8 and ~ 9 Mev.

Table II lists the results of the experiments performed to estimate the half-lives of these α emitters. The same lead target was used and the total current of the oxygen ions was the same. All that differed was the operating mode of the apparatus shown in Fig. 1. The third and fourth columns of the table list the total number of high energy α particles registered by the photographic plate. The calculation of the half-lives yields values of 35 ± 10 sec and ~ 1 min for the α emitters with $E_\alpha \approx 9$ Mev and $E_\alpha \approx 11.8$ Mev respectively.

2. Experiments on Irradiation of Lead with Carbon Ions

a) The interaction between accelerated O^{16} ions and lead can give rise to unknown isotopes of the elements from At to Th. If carbon ions are used for the bombardment, the heaviest elements among the products can be Ra. Experiments on irradiation of lead with carbon were undertaken to establish whether the radiation of interest to us ($E_\alpha \approx 9$ Mev and $E_\alpha \approx 11.8$ Mev) is connected with the de-

TABLE II

Number of experiment	$t_1=t_2=t_3$	$N(E_\alpha \approx 9 \text{ Mev})$	$N(E_\alpha \approx 11.8 \text{ Mev})$
1	40	360	80
2	50	180	46
3	100	26	14
4	250	3	3

decay of Ac and Th. It was found that the α -particle spectrum obtained by irradiation of natural lead with C^{12} ions is similar to that observed in the case of oxygen ions. Thus, this radiation is not connected with the decay of Ac or Th. It has been established that on going to C^{13} ions the yield of α radiation of energy ≈ 9 Mev and ≈ 11.8 Mev increases.

b) To ascertain the type of reactions that lead to the appearance of the isotopes emitting the high energy α particles, separated lead isotopes were irradiated by C^{13} ions of different energies.

Figure 4 shows the total α -particle spectrum, obtained after a brief irradiation of Pb^{208} with C^{13} ions of ~ 70 Mev ($t_1 = t_2 = 25$ sec, $t_3 = 3$ seconds). A comparison of this spectrum with those of Figs. 2 and 3 indicates a substantial change in the ratio of the densities of the α -particle groups near 12 and 9 Mev: the former group has become more intense.

Figure 5 shows the cross sections for the production of high-energy α -particle emitters as a function of the C^{13} -ion energy in the irradiation of Pb^{208} . The relative course of the curves is determined by the statistical errors indicated in the diagram. The accuracy of the determination of the absolute values of the cross sections is not better than 50%. The energy of bombarding particles was measured by displacing the target along the radius of the cyclotron chamber (after first establishing the dependence of the ion energy on the radius). It is seen from Fig. 5 that, independent of the energy of the bombarding particles, the yield of α

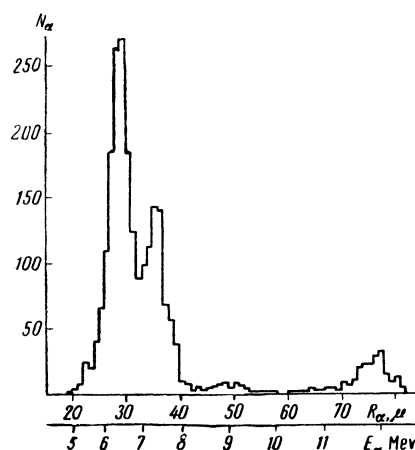

FIG. 4. Spectrum of α particles obtained by irradiating Pb^{208} with C^{13} ions.

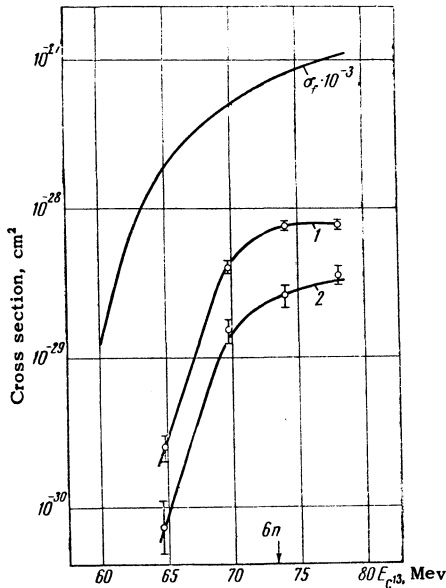

FIG. 5. Yield of α emitters with following particle energy: 1 - ~ 11.8 Mev, 2 - ~ 9 Mev, as a function of the energy of the C^{13} ions; σ_f - fission cross section, approximately equal to the cross section of production of the compound nucleus; the arrow indicates the threshold of reaction with emission of six neutrons.

particles of energies near 11.8 Mev is greater. Upon changing to a Pb^{207} target, the situation changes: for the maximum ion energy, the more probable reaction becomes the one that results in α radiation near 9 Mev (see Table III).

c) The comparatively longer lifetime of the α emitter of ~ 11.8 -Mev particles has allowed us to perform an experiment to detect the α decay that is genetically related to this radiation. After a brief irradiation of a Pb^{208} with a beam of C^{13} ions, the receiver of the recoil nuclei was rapidly extracted from the cyclotron chamber and placed in prolonged contact with the emulsion surface. Against the background of a large number of particles with energies less than 8 Mev, six tracks from the first group of high-energy α particles ($E_\alpha \approx 9$ Mev) and 64 tracks belonging to the second group of particles ($E_\alpha \approx 11.8$ Mev) were registered. Not a single pair of correlated tracks was observed.

III. DISCUSSION OF THE RESULTS

1) On the basis of the Rasmussen and Perlman⁷ classification of α emitters, it appears little likely for α particles of energy near 12 Mev to be emitted in the decay from the ground state of nuclei of elements from At to Ra. It is known that the energy of α decay increases with decreasing mass number, reaching a maximum for nuclei with $N = 128$ neutrons, and then rapidly decreases.

At the present time, two isotopes with $N = 128$

TABLE III

Target	$N_1(E_\alpha \approx 11.8 \text{ Mev})$	$N_2(E_\alpha \approx 9 \text{ Mev})$	N_1/N_2
Pb^{208}	589	235	2.5
Pb^{207}	96	148	0.65

neutrons are known: Po^{212} ($E_\alpha = 8.78$ Mev, $T_{1/2} = 3 \times 10^{-7}$ sec) and At^{213} ($E_\alpha = 9.2$ Mev). Extrapolation of the dependence of the α -decay energy on the mass number for Em, Fr, and Ra shows that in these elements the maximum α -particle energy (at $N = 128$) evidently does not exceed 10 Mev. It appears most probable to us that the α radiation with energy ~ 11.8 Mev is emitted from the excited nucleus produced during the decay of a certain parent nucleus, i.e., we deal here with the so-called "long-range" α particles. An analysis of the properties of the isotopes that can be formed as a result of interaction of carbon ions with lead shows that the main competing processes in the decay of these nuclei are α decay and K capture. The negative result of the experiment on the detection of genetically-related α particles indicates that the emitter of particles with energy ~ 11.8 Mev cannot be produced by α decay. It is thus proposed that the parent nucleus experiences K decay, while the daughter nucleus is most probably in the excited state ($E^* \approx 2.5$ Mev) and decays with emission of a high-energy α particle. The half-life of the α activity is determined here by the lifetime of the parent nucleus. For the nuclei now known, the intensity of the "long-range" particles is many orders smaller than the intensity of α radiation from the ground state. This is due to the small probability of production of a nucleus in the excited state and with the fact that the decay of the excited nucleus with emission of a high-energy α particle takes place in a smaller fraction of cases (the nucleus experiences principally radiative transition to the ground state).

In our case (see Fig. 4) the group of "long-range" α particles is more intense than the group with energy near 9 Mev; this can partially be ascribed to the decay of the same nucleus from the ground state. This circumstance can be explained by the fact that the probability of emission of an α particle increases very rapidly with energy. Estimates show that the lifetime of the Po - Ra nuclei relative to the "allowed" α decay with energy on the order of 12 Mev is 10^{-13} to 10^{-11} sec, i.e., in our case the decay of the excited state by emission of a high-energy α particle can compete successfully with radiative transition.

It is most probable that the parent nucleus is an

isotope with $N = 127$: At^{212} , Em^{213} , Fr^{214} , or Ra^{215} . The last two nuclei must be excluded from consideration in view of the fact that to produce them by bombardment of Pb^{208} with C^{13} ions we must have the reactions $(\text{C}^{13}, \text{p}6\text{n})$ and $(\text{C}^{13}, 6\text{n})$, which are energetically impossible at $E_{\text{C}^{13}} < 70$ Mev. In addition, the decay of Ra^{215} should lead to the appearance of two-pronged α -particle stars

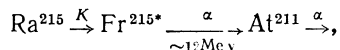

which has not been observed experimentally. The energy dependence of the cross section for the production of the α radiation of interest to us does not contradict the assumption of production of At^{212} [$(\text{C}^{13}, \text{p}4\text{n})$ reaction] and Em^{213} [$(\text{C}^{13}, \text{x}\alpha 4\text{n})$ reaction ($x = 0, 1$)]. There are still not enough grounds for giving preference to any of these isotopes.

It must also be assumed that these nuclei are produced in a metastable state — an assumption which is quite sensible, since the known nuclei with 127 neutrons (Bi^{210} and Po^{211}) have isomer levels. In the case of At^{212} this is necessary, if for no other reason than that the half-life of α particles of energy ~ 11.8 Mev does not coincide with the half-life of decay of At^{212} from the ground state (0.2 second). The metastability assumption allows us to explain the value of the excitation energy (~ 2.5 Mev) of the daughter nucleus and the small value of the cross section for its production. Let us consider the latter circumstance in greater detail for the case of Em^{213} production. The cross section of the $(\text{C}^{13}, \text{x}\alpha 4\text{n})$ reaction ($x = 0, 1$), which leads to the appearance of Em^{213} in the ground state, is $\sim 10^{-25}$ cm^2 at the maximum C^{13} ion energy (according to an estimate of the yield of Em^{212} from irradiation of Pb^{208} with C^{12} ions). The low yield of the daughter nucleus in the excited state (At^{213*}) could be related to the small probability of K capture of Em^{213} compared with α decay ($E_{\alpha} \approx 7.5$ Mev). In this case, however, the portion of the α -particle spectrum from 7 to 8 Mev should be hundreds of times more intense. In the case of $\text{Em}^{213\text{m}}$ production the yield of the α -particle emitter will be determined not only by the "fork" in the $\text{Em}^{213\text{m}}$ decay, but also by the probability of production of this nucleus and the $(\text{C}^{13}, \text{x}\alpha 4\text{n})$ reaction, which is less than that for Em^{213} .

The proposed mechanism for the appearance of "long-range" α particles is shown schematically in Fig. 6. This scheme should be considered as a working hypothesis, which will be verified and refined by further experiments.

2. The identification of the emitter of α particles of ~ 9 Mev is more difficult. This may be a

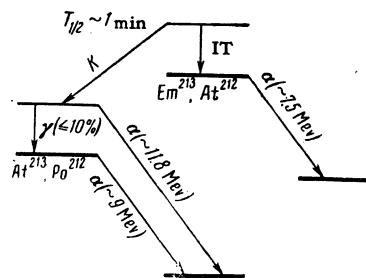

FIG. 6. Proposed scheme for a decay that leads to high-energy α particles; IT — isomer transition.

short-lived isotope in radioactive equilibrium with the parent nucleus, or else it may be a nucleus in the isomer state with a half-life 30 — 40 sec, which emits α particles of ~ 9 Mev (hindrance factor $\sim 10^7 - 10^8$). A known example of such a decay is the isomeric Po^{211} with a half-life of 25 sec, which emits 8.7-Mev α particles.⁸ The production of this very isotope in our experiments [via the Pb^{208} ($\text{C}^{13}, \text{x}\alpha 2\text{n}$) reaction ($x = 0$ to 2)] is not to be excluded.

3. A study of the properties of emitters of high-energy α particles, resulting from the interaction of oxygen and carbon ions with lead is of particular interest for those engaged in the production and investigation of new transuranic elements. The point is that certain isotopes of the far transuranic elements may have radioactive properties similar to the α emitters described in the present paper. This means that lead impurities in targets may produce a substantial background if physical methods are used to identify the new elements. This circumstance was taken into account in experiments on the production of the 102nd element, carried out at the Institute of Atomic Energy of the U.S.S.R. Academy of Sciences in 1957 — 1958.^{4,9} For a successful performance of these experiments a sensitive method was developed for activation analysis of lead impurities, and special measures were undertaken to purify the materials employed.

We note again that the interpretation of the results, suggested in Secs. 1 and 2, is tentative. Additional experiments, which are under preparation at the present time, will permit a more definite identification of the observed α emitters.

The authors express their gratitude to V. S. Zolotarev, for graciously supplying us with separated lead isotopes, and to A. M. Semchinova and D. M. Parfanovich for help with the work with the photoemulsions.

¹ G. N. Flerov, Proc. of 2nd U.N. Conf. on Peaceful Uses of Atomic Energy, **14**, p/2299, Geneva (1958).

² J. H. Fremlin, Physica, **22**, 1091 (1957).

³G. N. Flerov, Ядерные реакции при малых и энергиях, Тр. Всес. конф. 1957 г. (Trans. of 1957 All-union Conference on Nuclear Reactions at Low and Medium Energies) U.S.S.R. Acad. Sci., 1958, p. 489.

⁴G. N. Flerov et al., Dokl. Akad. Nauk SSSR 120, 73 (1958), Soviet Phys.-Doklady **3**, 546 (1959).

⁵A. Ghiorso, Proc. of the Conf. on Reactions between Complex Nuclei, Gatlinburg, 1958, p. 34.

⁶D. L. Hufford and B. F. Scott, The Transuranium Elements, NNES **2**, 1159 (1949).

⁷J. Rasmussen and J. Perlman, Handbuch der Physik, vol. 42, 1957.

⁸Jentschke, Inveland, and Kinsey, Phys. Rev. **96**, 231 (1954).

⁹G. N. Flerov et al., JETP **38**, 82 (1960), Soviet Phys. JETP **11**, in press.

Translated by J. G. Adashko
256