

*ANALYTIC CONTINUATION OF THE THREE-PARTICLE UNITARITY CONDITION.
SIMPLEST DIAGRAMS*

V. N. GRIBOV and I. T. DYATLOV

Leningrad Physico-Technical Institute, Academy of Sciences, U.S.S.R.

Submitted to JETP editor July 21, 1961

J. Exptl. Theoret. Phys. (U.S.S.R.) **42**, 196-210 (January, 1962)

The three-particle unitarity condition for the simplest class of diagrams is analytically continued with respect to the momentum transfer t . It involves an analytic function of t which possesses singularities only on the real axis, in accordance with the Mandelstam representation. The spectral function $\rho(s, t)$ is written in the form of a Feynman integral in which the denominators are replaced by δ functions. The integration over variables not fixed by the δ functions is carried out in a complex region. The shape of this region for the given class of diagrams is determined.

1. INTRODUCTION

THE view has frequently been taken in recent years that it is possible to use the analyticity and unitarity conditions to construct a theory in which the explicit introduction of an interaction Hamiltonian is not required [Gell-Mann (1956), Landau (1959)]. The first important step in this direction was taken by Mandelstam,^[1] who succeeded in continuing analytically the contribution of the two-particle intermediate state in the unitarity condition and thus obtained equations for the scattering amplitude in the two-particle approximation. It is clear that it is necessary for the further development of the theory to take account of the contribution of all intermediate states in the unitarity condition. The difficulties in carrying out this program are connected with the complicated structure of the contribution of the many-particle states as well as with the involved analytic properties of the amplitudes appearing in the intermediate states. Recently, Cutkosky^[2] pointed out a certain way of dealing with the many-particle states by constructing spectral functions with the help of Feynman diagrams in which certain lines represent δ functions. Since the spectral functions differ from zero only in the nonphysical region of the variables, they will in general involve integrals over complex values of the virtual momenta. If all components of the virtual momenta are uniquely determined by the δ functions, as in the case of square diagrams, the fact that the momenta are complex is inconsequential. If this is not the case (and this will be the situation whenever we are dealing with many-particle states), the region of integration is undefined and the integrals are meaningless.

Up to the present time we know of no other possibility of defining the region of integration than by analytic continuation of the unitarity condition away from the physical region. In the present paper we carry out the analytic continuation of the three-particle unitarity condition for the simplest class of diagrams. We shall show that the analytic properties of the absorptive part are in agreement with the Mandelstam representation and that the spectral functions are given by Feynman integrals containing δ functions. The regions of integration found are complex not only in the momentum components, but also in the invariants.

In a future publication we shall generalize these results for a more general class of diagrams. Although the method of the present paper for finding the spectral functions is mathematically quite natural and definite, it can hardly be applied to the investigation of the higher intermediate states in view of the complicated structure of the unitarity conditions. The formulation of a theory based on the analyticity and unitarity condition will therefore only become possible when simpler and more general principles for setting up the equations will have been found. Unfortunately, the results of this paper show that the character of the regions of integration in the expressions for the spectral functions depends critically on the details of the analytic properties of the amplitudes. This, of course, makes it difficult to give a general recipe.

2. TWO- AND THREE-PARTICLE UNITARITY CONDITIONS

In this section we write down the unitarity condition in terms of integrals over invariant vari-

ables, which will be convenient for the subsequent discussion.

The unitarity condition for the transformation of two particles with momenta \mathbf{p}_1 and \mathbf{p}_2 into particles with momenta \mathbf{p}_3 and \mathbf{p}_4 (Fig. 1) with account of the two- and three-particle intermediate states has the form

$$\text{Im } A = A_1^{(2)} + A_1^{(3)};$$

$$\begin{aligned} A_1^{(2)}(\rho_1, \rho_2; \rho_3, \rho_4) \\ = \frac{1}{2(2\pi)^2} \int d^4 p_5 d^4 p_6 A(\rho_1, \rho_2; p_5, p_6) A^*(p_5, p_6; \rho_3, \rho_4) \\ \times \delta(\rho_5^2 - m_5^2) \delta(\rho_6^2 - m_6^2) \delta^{(4)}(\rho_1 + \rho_2 - p_5 - p_6), \end{aligned} \quad (1)$$

$$\begin{aligned} A_1^{(3)}(\rho_1, \rho_2; \rho_3, \rho_4) \\ = \frac{1}{2(2\pi)^3} \int d^4 p_5 d^4 p_6 d^4 p_7 A(\rho_1, \rho_2; p_5, p_6, p_7) \\ \times A^*(p_5, p_6, p_7; \rho_3, \rho_4) \delta(p_{50}) \delta(\rho_5^2 - m_5^2) \delta(p_{60}) \\ \times \delta(\rho_6^2 - m_6^2) \delta(p_{70}) \delta(\rho_7^2 - m_7^2) \\ \times \delta^{(4)}(\rho_1 + \rho_2 - p_5 - p_6 - p_7), \end{aligned} \quad (2)$$

where the normalization of the invariant amplitudes A is determined by the condition

$$S = 1 + i(2\pi)^4 \delta(\sum p_i - \sum p_f) A \left[\prod_i (2\epsilon)_i \prod_f (2\epsilon)_f \right]^{-1/2}. \quad (3)$$

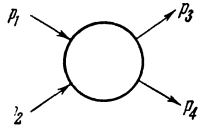

FIG. 1

All amplitudes A are functions of the invariants $(\mathbf{p}_i + \mathbf{p}_k)^2$. The quantities $A_1^{(2)}$ and $A_1^{(3)}$ are functions of $s = (\mathbf{p}_1 + \mathbf{p}_2)^2$ and $t = (\mathbf{p}_1 - \mathbf{p}_3)^2$. The amplitudes $A(\rho_1, \rho_2; p_5, p_6)$ and $A(p_5, p_6; \rho_3, \rho_4)$, which enter in (1), are functions of $s_{12} = (\mathbf{p}_1 + \mathbf{p}_2)^2$, $t_{15} = (\mathbf{p}_1 - \mathbf{p}_5)^2$ and $s_{34} = (\mathbf{p}_3 + \mathbf{p}_4)^2$, $t_{35} = (\mathbf{p}_3 - \mathbf{p}_5)^2$, respectively. Owing to conservation laws we have $s_{12} = s_{34} = s$. As the two integration variables remaining in (1) after elimination of the δ functions one usually chooses the polar angles ϑ and φ of the momentum \mathbf{p}_5 or \mathbf{p}_6 of one of the intermediate particles in the center of mass system (c.m.s.). Instead of these, it is convenient to choose $z_{15} = \cos \theta_{\mathbf{p}_1 \mathbf{p}_5}$ and $z_{35} = \cos \theta_{\mathbf{p}_3 \mathbf{p}_5}$. In these variables we have

$$\begin{aligned} d\cos \vartheta d\varphi = dz_{15} dz_{35} / \sqrt{-K(z_{13}, z_{15}, z_{35})}, \\ -K(z_{ik}) = 1 + 2z_{13}z_{15}z_{35} + z_{13}^2 - z_{15}^2 - z_{35}^2 = \begin{vmatrix} 1 & z_{13} & z_{15} \\ z_{13} & 1 & z_{35} \\ z_{15} & z_{35} & 1 \end{vmatrix} \end{aligned} \quad (4)$$

where $z_{13} = \cos \theta_{\mathbf{p}_1 \mathbf{p}_3}$. The variables z_{13} , z_{15} , and

z_{35} are connected linearly with the invariants $t = t_{13}$, t_{15} , and t_{35} :

$$t_{ik} = (\rho_i - \rho_k)^2 = m_i^2 + m_k^2 - 2\rho_{i0}\rho_{k0} + 2\rho_i\rho_k z_{ik}. \quad (5)$$

In these variables Eq. (1) takes the form

$$A_1^{(2)}(s, t) = \frac{1}{16\pi^2} \frac{p_5}{\sqrt{s}} \int \frac{dz_{15} dz_{35}}{\sqrt{-K(z, z_{15}, z_{35})}} A(s, t_{15}) A^*(s, t_{35}). \quad (6)$$

$\mathbf{p}_i = |\mathbf{p}_i|$ is the momentum of the i -th particle in the c.m.s. It is simply related to s and the mass. The integration in (5) goes over the region where $-K(z, z_{15}, z_{35}) \geq 0$. $A_1^{(3)}(s, t)$ can be written in an analogous form. After integration over p_7 and the lengths of the three dimensional vectors \mathbf{p}_5 and \mathbf{p}_6 the phase volume appearing in (2) takes, in the c.m.s., the form

$$\frac{1}{4} |\mathbf{p}_5| |\mathbf{p}_6| dp_{50} dp_{60} d\Omega_{\mathbf{p}_5} d\Omega_{\mathbf{p}_6} \delta[(\rho_1 + \rho_2 - p_5 - p_6)^2 - m_7^2].$$

The integration over the invariants can be carried out in various ways. In place of the variables p_{50} and p_{60} it is natural to introduce the variables $s_{67} = (\mathbf{p}_6 + \mathbf{p}_7)^2$ and $s_{57} = (\mathbf{p}_5 + \mathbf{p}_7)^2$, respectively:

$$p_{50} = \frac{s + m_5^2 - s_{67}}{2\sqrt{s}}, \quad p_{60} = \frac{s + m_6^2 - s_{57}}{2\sqrt{s}}.$$

Instead of the polar angles of the vector \mathbf{p}_5 we introduce the cosines of the angles relative to the vectors \mathbf{p}_1 and \mathbf{p}_3 : z_{15} and z_{35} . Then

$$d\Omega_{\mathbf{p}_5} = dz_{15} dz_{35} / \sqrt{-K(z_{13}, z_{15}, z_{35})}.$$

The angles of the vector \mathbf{p}_6 are replaced by the cosines of the angles relative to \mathbf{p}_2 and \mathbf{p}_4 :

$$d\Omega_{\mathbf{p}_6} = dz_{26} dz_{46} / \sqrt{-K(z_{24}, z_{26}, z_{46})}.$$

In these variables

$$\delta[(\rho_1 + \rho_2 - p_5 - p_6)^2 - m_7^2] = \delta[2|\mathbf{p}_5| \cdot |\mathbf{p}_6| (z_{56} - z_{56}^0)],$$

where

$$\begin{aligned} z_{56}^0 = [m_5^2 + m_6^2 + 2p_{50}p_{60} + s \\ - 2\sqrt{s}(p_{50} + p_{60})] / 2|\mathbf{p}_5| \cdot |\mathbf{p}_6|, \end{aligned} \quad (7)$$

and $z_{56} = \cos \theta_{\mathbf{p}_5 \mathbf{p}_6}$, being the cosine of an angle between two vectors whose directions are given relative to the fixed vectors $\mathbf{p}_1 = -\mathbf{p}_2$ and $\mathbf{p}_3 = -\mathbf{p}_4$, is expressed in terms of z_{15} , z_{35} , $z_{26} = -z_{16}$, $z_{46} = -z_{36}$, and $z = z_{13} = z_{24}$. The relation between z_{56} and the other z_{ik} mentioned above is given by the condition that the determinant

$$\square(z_{ik}) = \begin{vmatrix} 1 & z_{13} & z_{15} & -z_{26} \\ z_{13} & 1 & z_{35} & -z_{46} \\ z_{15} & z_{35} & 1 & z_{56} \\ -z_{26} & -z_{46} & z_{56} & 1 \end{vmatrix} \quad (8)$$

vanish. This is equivalent to the requirement that all four vectors \mathbf{p}_1 , \mathbf{p}_3 , \mathbf{p}_5 , and \mathbf{p}_6 lie in a three-dimensional space.

It follows from (8) that

$$z_{56} = (1 - z_{13}^2)^{-1} [-z_{15} (z_{26} - z_{13}z_{46}) - z_{35} (z_{46} - z_{13}z_{26}) \pm \sqrt{K(z_{13}, z_{15}, z_{35}) K(z_{24}, z_{26}, z_{46})}]. \quad (9)$$

It is easily seen that, using (8) and (9), the three-particle unitarity condition can be written in the form

$$A_1^{(3)}(s, t) = \frac{1}{64 (2\pi)^5 s} \int ds_{57} ds_{67} dz_{15} dz_{35} dz_{26} dz_{46} \delta[\square(z_{ik})] \times A(s, s_{57}, s_{67}, t_{15}, t_{26}) A^*(s, s_{57}, s_{67}, t_{35}, t_{46}). \quad (10)$$

where the t_{ik} are related to the z_{ik} by (5).

We note that $K(z_{ik})$ is analogous to $\square(z_{ik})$ in the sense that the condition $K(z_{ik}) = 0$ is the requirement that three vectors lie in a two-dimensional space. If the z_{ik} in $K(z_{ik})$ and $\square(z_{ik})$ are expressed in terms of the invariant t_{ik} and s , s_{57} , s_{67} , the vanishing of (4) and (8) implies that the four-dimensional vectors $p_1 + p_2$, p_1 , p_3 , p_5 or $p_1 + p_2$, p_1 , p_3 , p_5 , p_6 lie in a three- or four-dimensional space, respectively. It is easy to show that the expressions for K and \square in terms of the invariants are unchanged under the replacement of any of the defining vectors by an arbitrary linear combination of the same, e.g.,

$$K'(z_{15}, z_{35}, z_{26}) \sim K(p_1, p_2, p_5, p_6) = K(p_1, p_5, p_6, p_7).$$

3. ANALYTIC CONTINUATION OF THE TWO-PARTICLE UNITARITY CONDITION

The two-particle unitarity condition (6) has been continued analytically by Mandelstam [1] by way of an explicit computation of the integral over z_{15} and z_{35} with the help of the dispersion relations in the momentum transfer for the amplitudes $A(s, t_{15})$ and $A^*(s, t_{35})$. A method based on the explicit evaluation of the integrals in the unitarity condition cannot be carried over to the investigation of the contribution of the three-particle intermediate state. We therefore indicate a method which makes use of the same analytic properties of the amplitudes A and A^* , but which does not require an explicit computation of the integral. This will at the same time serve as an introduction to the study of the three-particle state. A reading of this section is not essential for the understanding of the rest of the paper.

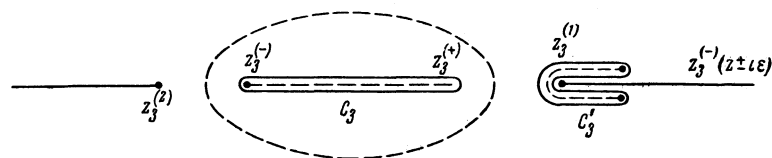

FIG. 2

Let us rewrite formula (6), omitting for simplicity all nonessential factors and writing $z_{15} = z_1$, $z_{35} = z_3$:

$$A_1^{(3)}(z) = \int_{-1}^{+1} dz_1 f(z, z_1) A(z_1), \quad (11)$$

where

$$f(z, z_1) = \frac{1}{2} \int_{C_3} \frac{dz_3 A^*(z_3)}{\sqrt{-K(z, z_1, z_3)}}. \quad (12)$$

The integration between the two roots of K in (6) has been replaced by the closed contour C_3 shown in Fig. 2.

The roots of K are

$$z_3^{(\pm)} = zz_1 \pm \sqrt{(1 - z^2)(1 - z_1^2)}.$$

The points $z_3^{(1), (2)}$ determine the beginning of the cuts or the poles of the functions $A^*(z_3)$ ($|z_3^{(1), (2)}| > 1$). The function $f(z, z_1)$ clearly has no singularities at the points $z = \pm 1$, at which $z_3^{(\pm)}$ become complex, since we can always deform the contour C_3 (dotted line). The passage through the boundary of the physical region shows up only in the fact that the region of integration in the unitarity condition becomes complex.

Let us consider $f(z, z_1)$ as a function of z_1 for fixed real z with $|z| > 1$. It has a singularity only at those values of z_1 for which $z_3^{(\pm)}$ lie on the cuts of $A^*(z_3)$ (to the right of $z_3^{(1)}$ or to the left of $z_3^{(2)}$), i.e., at the points

$$z_1^{(\pm)} = zz_3 \pm \sqrt{(z^2 - 1)(z_3^2 - 1)}, \quad (13)$$

where $z_3 > z_3^{(1)}$ or $z_3 < z_3^{(2)}$.

Let us now turn to the integral (11) and consider the complex plane of z_1 (Fig. 3), where $z_1^{(\pm)}$ are the singular points of the function $f(z, z_1)$ [Eq. (13)], which for definiteness have been placed to the right of $+1$ ($zz_3 > 0$), and $z_1^{(1)}$ and $z_1^{(2)}$ are the ends of the cuts of the function $A(z_1)$. We study the motion of the singular points $z_1^{(\pm)}$ as z is varied. If $zz_3 > 0$, the point $z_1^{(\pm)}$ is always to the right of $+1$ and moves to the right without

FIG. 3

touching the integration contour as $|z| > 1$ is increased. At the same time $z_1^{(-)}$ moves first to the left, reaches the point $z_1 = +1$ for $z = z_3$ and then turns back toward the right. At this moment the contour of integration is "caught" (see, e.g., [4]). For $|z| > |z_3|$ the integration contour is deformed in the analytic continuation and assumes the shape shown in Fig. 3 (contour C_1).

The point $z = z_3$ is not a singular point of the function $A_1^{(2)}(z)$, since the two possibilities of going around the point $+1$ with the singularity $z_1^{(-)}$ (corresponding to $z \pm i\varepsilon$) lead to the same result. A singularity of $A_1^{(2)}(z)$ comes about when the point $z_1^{(-)}$, which pushes the integration contour along with it, coalesces with $z_1^{(1)}$ (the points $z_1^{(\pm)}$ do not coalesce for finite z). If we had considered the analytic continuation for $zz_3 < 0$, we would have found that the singularity $z_1^{(+)}$ "catches" the contour in the neighborhood of the point $z_1 = -1$ and that $A_1^{(2)}(z)$ has a singularity for $z_1^{(+)} = z_1^{(2)}$. Thus the function $A_1^{(2)}(z)$ has singularities, i.e., becomes complex at values of z for which $z_1^{(-)} \geq z_1^{(1)}$ ($zz_3 > 0$) or $z_1^{(+)} \leq z_1^{(2)}$ ($zz_3 < 0$), which is equivalent to the conditions

$$\begin{aligned} z &\geq z_1 z_3 + \sqrt{(z_1^2 - 1)(z_3^2 - 1)}, & z_1 z_3 > 0, \\ z &\leq z_1 z_3 - \sqrt{(z_1^2 - 1)(z_3^2 - 1)}, & z_1 z_3 < 0, \end{aligned} \quad (14)$$

where z_1 and z_3 are points lying on the cuts of the functions $A(z_1)$ and $A^*(z_3)$, respectively.

Formula (14) implies, in particular, that, if $A(z_1)$ and $A^*(z_3)$ have no singularities for complex z_1 or z_3 , then $A_1^{(2)}(z)$ also has no singularities for complex z . In order to determine the imaginary part of $A_1^{(2)}(z)$, i.e., the Mandelstam function ρ , we must compute the difference of the integrals along the contour C_1 on the two branches of the cuts of the functions $A(z_1)$. For example, considering the contribution from the region $z_1 > z_1^{(1)}$ and $z_3 > z_3^{(1)}$ for $z > 0$, we can write

$$\begin{aligned} \rho^{(2)}(z) &= \frac{1}{2i} [A_1^{(2)}(z + i\varepsilon) - A_1^{(2)}(z - i\varepsilon)] \\ &= \int_{C_1} f(z, z_1) \frac{1}{2i} [A(z_1 + i\varepsilon) - A(z_1 - i\varepsilon)] dz_1 \\ &= \int_{z_1^{(1)}}^{z_1^{(-)}(z)} dz_1 A_3(z_1) [f(z, z_1 + i\varepsilon) - f(z, z_1 - i\varepsilon)]. \end{aligned}$$

We have used the notation $A_3(z_1) = [A(z_1 + i\varepsilon) - A(z_1 - i\varepsilon)]/2i$. Furthermore

$$\begin{aligned} &f(z, z_1 + i\varepsilon) - f(z, z_1 - i\varepsilon) \\ &= 2 \int_{z_3^{(1)}}^{z_3^{(-)}} \frac{dz_3}{\sqrt{K(z, z_1, z_3)}} \frac{1}{2i} [A^*(z_3 + i\varepsilon) - A^*(z_3 - i\varepsilon)], \end{aligned} \quad (15a)$$

where $\sqrt{K} > 0$. Writing $A_3^*(z_3) = [A^*(z_3 + i\varepsilon) - A^*(z_3 - i\varepsilon)]/2i$, we obtain

$$\rho^{(2)}(s, z) = 2 \int \frac{dz_1 dz_3 A_3(z_1) A_3^*(z_3)}{\sqrt{K(z, z_1, z_3)}} \vartheta(z - z_1 z_3 - \sqrt{(z_1^2 - 1)(z_3^2 - 1)}). \quad (15b)$$

If we add to (15b) the contribution from the regions $z_1 z_3 < 0$, $z_1 < 0$, $z_3 < 0$, we obtain the known formula of Mandelstam.^[1]

Formula (15) is easily proved. It is only necessary to investigate the behavior of the contour C_3 and the integral (12) as one comes to values of z and z_1 for which the integration in (11) is carried out after the "pinching" of the contour for z_1 . Then $f(z, z_1 + i\varepsilon) - f(z, z_1 - i\varepsilon)$ is given by an integral along the contour C_3' (Fig. 2), and we obtain (15a) and (15b).

In conclusion we note that since all the integration contours lie in finite regions of the z_1 and z_3 planes if z is finite, the behavior of $A(z_1)$ and $A(z_3)$ at infinity has no bearing whatever on our results.

The use of this procedure for continuing the three-particle unitarity condition (10) requires the knowledge of the analytic properties of the amplitudes A and A^* of reactions involving five particles. It was just the knowledge of these properties for four-point diagrams which enabled one to continue the two-particle unitarity condition in its general form.

The analytic properties of five-point diagrams have not been considered at all in the general case. Let us therefore study first the simplest diagram for a three-particle state. This will give us an understanding of certain general properties of the three-particle intermediate state under conditions where the five-point amplitudes A and A^* have the simplest analytic properties. In a later publication we shall discuss the effect of more complicated analytic properties of A and A^* .

4. ANALYTIC CONTINUATION OF THE THREE-PARTICLE UNITARITY CONDITION FOR THE SIMPLEST DIAGRAMS

Let us consider the contribution to the unitarity condition from the diagram shown in Fig. 4. In

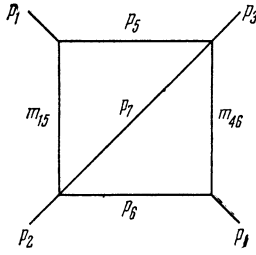

FIG. 4

this case the quantities A and A^* entering in (11) have the form

$$A = \frac{1}{t_{15} - m_{15}^2} = \frac{1}{2\rho_1\rho_5} \frac{1}{z_{15} - z_{15}^0},$$

$$A^* = \frac{1}{t_{46} - m_{46}^2} = \frac{1}{2\rho_4\rho_6} \frac{1}{z_{46} - z_{46}^0},$$

$$z_{15}^0 = z_{15}^0(s, s_{67}) = \frac{m_{15}^2 + 2\rho_{10}\rho_{50} - m_1^2 - m_5^2}{2\rho_1\rho_5} > 1,$$

$$z_{46}^0 = z_{46}^0(s, s_{57}) = \frac{m_{46}^2 + 2\rho_{40}\rho_{60} - m_4^2 - m_6^2}{3\rho_4\rho_6} > 1. \quad (16)$$

All of the following discussion will be valid for arbitrary diagrams for which A and A^* in formula (10) depend only on t_{15} and t_{46} . The resulting formulas are all finally integrated over m_{15}^2 and m_{46}^2 .

We integrate over z_{35} , using the fact that in $\delta(\square)$ we have $\square = (1 - z_{26}^0)(z_{35} - z_{35}^{(+)})(z_{35} - z_{35}^{(-)})$ and

$$(1 - z_{26}^0)(z_{35}^{(+)} - z_{35}^{(-)}) = 2\sqrt{K(z, z_{26}, z_{46})K(z_{15}, z_{56}^0, z_{16})},$$

and find

$$A_1^{(3)}(s, t) = \frac{1}{(2\pi)^2} \int \frac{ds_{57} ds_{67}}{4\rho_4\rho_6\rho_1\rho_5} \frac{dz_{15} dz_{26} dz_{46}}{\sqrt{K(z, z_{46}, z_{26})K(z_{15}, z_{56}^0, -z_{26})}} \times \frac{1}{(z_{46} - z_{46}^0)(z_{15} - z_{15}^0)} \quad (17)$$

where a factor $[64(2\pi)^3]^{-1}$ has been omitted.

The integration goes over a region where each $-K(z_{ik}) > 0$. The boundaries of the region of integration over s_{57} and s_{67} are automatically given by the condition $|z_{56}^0| \leq 1$. The explicit form of this condition is given in the Appendix I [formula (AI.7)]. Formula (17) could have been obtained directly from (2) by introducing the integration variables z_{15} , z_{26} , z_{46} , and z_{56} .

The analytic properties of $A_1^{(3)}(s, t)$ [formula (17)] as a function of t , i.e., z , could be investigated in the same way as in Sec. 2 without ever carrying out a single integration in (17). However, in order not to overburden the discussion with inessential complications, we integrate over z_{15} and z_{46} , since this can be readily done. As a result we obtain

$$A_1^{(3)}(s, t) = \int_{-1}^{+1} \frac{ds_{57} ds_{67}}{4\rho_4\rho_6\rho_1\rho_5} \int_{-1}^{+1} dz_{26} / \sqrt{K(z, z_{26}, z_{46}^0)K(z_{15}^0, z_{56}^0, -z_{26})}. \quad (18)$$

The first step in the analytic continuation of (18) is evidently the study of the integral over z_{26} . The integrand has the following singularities in the complex z_{26} plane:

$$z_{26}^{(\pm)} = z z_{46}^0 \pm \sqrt{(z^2 - 1)[(z_{46}^0)^2 - 1]}, \quad (19a)$$

$$z_{26}^{\prime, \prime\prime} = z_{15}^0 z_{56}^0 \pm \sqrt{[(z_{56}^0)^2 - 1][(z_{15}^0)^2 - 1]}. \quad (19b)$$

These are shown in Fig. 5.

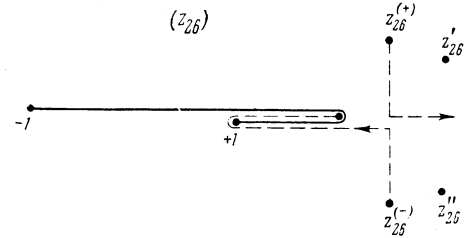

FIG. 5

Since $|z_{56}^0| \leq 1$ and $z_{15}^0 > 1$ in the region of integration, $z_{26}^{\prime, \prime\prime}$ always lie in the complex plane except when $|z_{56}^0| = 1$, which corresponds to the boundary of the region of integration over s_{56} and s_{67} . The singularities $z_{26}^{(\pm)}$ lie in the complex plane if z lies in the physical region, $|z| < 1$ ($z_{46}^0 > 1$). If $z = \pm 1$, they fall on the real axis at the point $z_{26} = \pm z_{46}^0$. Since, in so doing, they do not touch the integration contour ($z_{46}^0 > 1$), the points $z = \pm 1$ are not singular.

First we shall continue (18) along the real axis in z , and then show that $A_1^{(3)}(s, t)$ has no singularities for complex $z(t)$. As we continue (18) into the region $z > 1$, the singularity $z_{26}^{(+)}$ moves to the right along the real axis of z_{26} , and $z_{26}^{(-)}$ moves to the left, reaching the point $+1$ for $z = z_{46}^0$, after which it turns back to the right, taking along the contour of integration exactly as in the case of the two-particle state (Sec. 3).

Since $z_{26}^{(-)}$ and $z_{26}^{(+)}$ do not coincide for finite z , the integral will have a singularity only if $z_{26}^{(-)}$ coalesces with z_{26}^{\prime} or $z_{26}^{\prime\prime}$. For real z , this can occur only if s_{57} and s_{67} lie on the boundary of the region of integration [$(z_{56}^0)^2 = 1$]. Under these conditions the point of coalescence need not be a singular point of the whole function $A_1^{(3)}(s, t)$, but is a "pinching point" of the contour of integration for one of the variables s_{57} and s_{67} . The second step in the analytic continuation of (18) will therefore consist in a more detailed investigation of the integration over one of these variables, for example, s_{67} .

Let us rewrite the integral (18) in the form

$$A_1^{(3)}(s, t) = \int_{(m_5+m_7)^2}^{(\sqrt{s}-m_6)^2} \frac{ds_{57}}{2p_4 p_6} \int_{-1}^{+1} \frac{dz_{26} f(s_{57}, z_{26})}{\sqrt{K(z, z_{26}, z_{46}^0)}}, \quad (20)$$

$$f(s_{57}, z_{26}) = \int \frac{ds_{67}}{2p_1 p_5} \frac{\vartheta(1 - (z_{56}^0)^2)}{\sqrt{K(z_{15}^0, z_{56}^0, -z_{26})}}. \quad (21)$$

We have used the fact that z_{46}^0 is independent of s_{67} . The integral (21) can be evaluated, since $4p_1 p_5^2 K(z_{15}^0, z_{56}^0, -z_{26})$ is a quadratic trinomial in the variable s_{67} (see Appendix I). This can be done particularly easily, if we integrate (17) first over s_{67} and then over z_{15} . However, we shall not carry out these integrations, since the analysis of the more complicated diagrams is more conveniently based on a study of $f(s_{57}, z_{26})$ in the form (21).

Let us consider $f(s_{57}, z_{26})$ as a function of z_{26} and find the value of z for which the singularities of $f(s_{57}, z_{26})$ coincide with $z_{26}^{(-)}(z)$ [formula (19a)]. If such a coincidence is possible with $(m_5 + m_7)^2 < s_{57} < (\sqrt{s} - m_6)^2$, the singularity of $A_1^{(3)}(s, z)$ can be found without investigating the integral over s_{57} . If this coincidence occurs only for limiting values of s_{57} , the properties of the integral over s_{57} also have to be examined. For real z_{26} the roots of $K(z_{15}^0, z_{56}^0, -z_{26})$ never fall inside the region of integration over s_{67} , since, according to (19b), the points $(z_{56}^0)^2 < 1$ give rise to complex values of z_{26} . However, they may coincide with the boundary of the region of integration at $(z_{56}^0)^2 = 1$.

Let us consider the complex s_{67} plane (Fig. 6), where $s_{67}^{(1),(2)}$ are the end points of the integration contour, and $s_{67}^{(+)}$ are the roots of $4p_1 p_5^2 K(z_{15}^0, z_{56}^0, -z_{26})$. We have

$$\begin{aligned} s_{67}^{(\pm)} = & [s_{57}^2 - 2(m^2 + t_{26})s_{57} \\ & + (m^2 - t_{26})^2]^{-1} \{ s [t_{26}(t_{26} - m^2 - s_{57}) \\ & + (m_{15}^2 - m^2)(m^2 - s_{57} - t_{26})] \\ & + m_{15}^2 [s_{57}^2 - s_{57}t_{26} + m^2(t_{26} - m^2)] \\ & + m^2 [s_{57}^2 - 4m^2 s_{57} + (t_{26} - m^2)(t_{26} - 3m^2)] \\ & \pm 2m \sqrt{s(t_{26} - t_{26}^{(1)})(t_{26} - t_{26}^{(2)})(t_{26} - t_{26}')(t_{26} - t_{26}'')} \}; \end{aligned} \quad (22)$$

$$\begin{aligned} t_{26}^{(1),(2)} = & m^2 + m_{15}^2 s_{57} / 2m^2 \\ & \pm \sqrt{s_{57}(s_{57} - 4m^2) m_{15}^2 (m_{15}^2 - 4m^2) / 2m^2, \\ & (t_{26} - t_{26}'')(t_{26} - t_{26}') = 4p_2^2 p_6^2 (z_{26}^2 - 1)}. \end{aligned} \quad (23)$$

From this point on we use the variable t_{26} rather than z_{26} , since all formulas have a simpler form

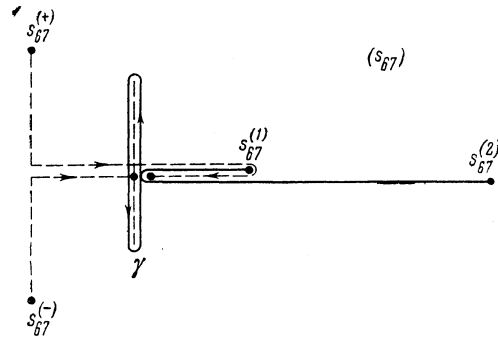

FIG. 6

in the former variable. The connection between z_{26} and t_{26} is given by (5). Furthermore, we shall, for simplicity, write all complicated formulas in the main body of the paper for the case in which all masses m_i (Fig. 4), but not m_{15} and m_{46} , are equal to m . The consideration of unequal masses leads to rather more complicated expressions without introducing any essential new features. The formulas for the case of arbitrary masses are given in Appendix I.

If t_{26} lies in the physical region ($|z_{26}| < 1$), $s_{67}^{(+)}$ lie in the complex plane. For $z_{26} = 1$ they fall on the real axis to the left of the contour of integration for s_{67} and then separate along the real axis. For some t_{26} (or z_{26}) $s_{67}^{(+)}$ reaches $s_{67}^{(1)}$ and then returns as t_{26} is increased, taking along the integration contour. $f(s_{57}, t_{26})$ can have a singularity only for such values of t_{26} at which $s_{67}^{(+)}$ coalesces with $s_{67}^{(-)}$.* It is seen from (22) that this occurs at the points $t_{26} = t_{26}^{(1),(2)}$.

In the region of integration over s_{57} the $t_{26}^{(1),(2)}$ and the corresponding $z_{26}^{(1),(2)}$ are real if $m_{15}^2 > (m_1 + m_5)^2$. Therefore $z_{26}^{(1),(2)}$ may coalesce with $z_{26}^{(-)}(t)$, which is real for real t , if $(m_5 + m_7)^2 \leq s_{57} \leq (\sqrt{s} - m_6)^2$, provided that $m_{15}^2 > (m_1 + m_5)^2$. For $m_{15}^2 < (m_1 + m_5)^2$ this coincidence can occur only if $s_{57} \leq (m_5 + m_7)^2$, i.e., at the boundary of the region of integration.

a) Let us consider first the case $m_{15}^2 > (m_1 + m_5)^2$. The singular curves for the integrand of (20) in the t_{26}, s_{57} plane are shown in Fig. 7.

The curve LMN is the boundary of the physical region of the variables s_{57} and t_{26} , over which we integrated originally in (18) ($z_{26}^2 \leq 1$ or $t_{26}'' \leq t_{26} \leq t_{26}'$). The curves $At_i Bt_i$ correspond to Eq. (19a) ($z_{26}^{(-)}$ regarded as an expression in t_{26} and s_{57} for different values of $t = t_i$). They all touch the curve LMN in the points Bt_i ($Bt_i \rightarrow M$ for $t_i \rightarrow \infty$).

*The singularity of $f(s_{57}, t_{26})$ corresponding to the vanishing of the denominator in (22) (curve PQ of Fig. 7) will be discussed later, as it does not play any role in the determination of the Karplus curve for the diagram of Fig. 4.

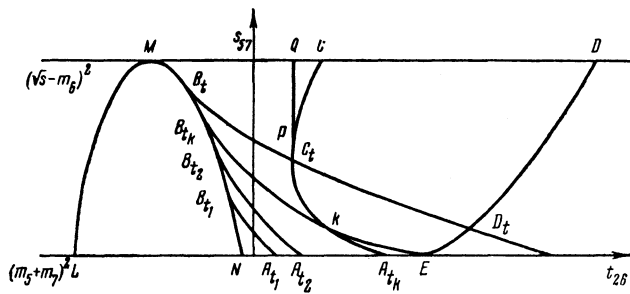

FIG. 7

In the new variables expression (19a) takes on the form

$$t_{26}^{(\pm)}(t) = m_{46}^2 + \frac{t(s - s_{57} - 3m^2 + 2m_{46}^2)}{s - 4m^2} \pm \frac{2m}{s - 4m^2} \sqrt{\frac{t}{s}(t + s - 4m^2)(s_{57} - s'_{57})(s_{57} - s''_{57})}$$

$$s'_{57} = m^2 + m_{46}^2 s / 2m^2 \pm \sqrt{s(s - 4m^2)m_{46}^2(m_{46}^2 - 4m^2) / 2m^2} \quad (24)$$

The curve CED is the singular curve of the function $f(t_{26}, t_{57})$ ($t_{26}^{(1),(2)}$). The "catching" of the contour in the z_{26} plane implies in the s_{57}, t_{26} plane that, for a given $t = t_i$, the integration goes from the curve LM to the curve MN above the tangent point B_{t_i} and to the curve $A_{t_i}B_{t_i}$ below the tangent point. A singularity of $A_1^{(3)}(s, t)$ occurs at a value of $t = t(s)$ for which the curve $A_{t_i}B_{t_i}$ touches the curve CE at some point k . Indeed, for $t > t(s)$, the region of integration in t_{26} and s_{57} includes part of the region behind the curve CE (Fig. 7), but for these values of t_{26} and s_{57} the function $f(s_{57}, t_{26})$ is already complex, i.e., $A_1^{(3)}$ has an imaginary part. The singularities $t(s)$ correspond to the Karplus curve for the graph of Fig. 4 with the asymptotes

$$t = (m_{15} + m_7 + m_{46})^2, \quad s = (m_5 + m_7 + m_6)^2$$

[$t = (m_{15} + m_{46} + m)^2$ and $s = 9m^2$ for equal masses]. It is seen from (23) and (24) that in our case [$m_{15}^2 > (m_1 + m_5)^2$] the curves $t_{26}^{(1),(2)}$ and t_{26} can intersect only for real t , i.e., $A_1^{(3)}(s, t)$ has no complex singularities.

From this analysis we can easily obtain a formula for $\rho^{(3)}(s, t) = \text{Im } A_1^{(3)}(s, t)$ for real t .

For this purpose we note that we have after the "catching" of the contour in t_{26} :

$$A_1^{(3)}(s, t) = 2s \int_{LMN} \frac{ds_{57} dt_{26} f(s_{57}, t_{26})}{\sqrt{K(t, t_{26}, s_{57})}} + 4s \int_{NB_t A_t} \frac{ds_{57} dt_{26} f(s_{57}, t_{26})}{\sqrt{K(t, t_{26}, s_{57})}} \quad (25)$$

$$K(t, t_{26}, s_{57}) = 4s 4\rho_1^2 \rho_2^2 \rho_3^2 K(z, z_{26}, z_{46}^0) = s(s - 4m^2)(t_{26} - t_{26}^{(+)}(t))(t_{26} - t_{26}^{(-)}(t)) \quad (26)$$

$t_{26}^{(\pm)}(t)$ are given by (24). According to the preceding discussion, the integration in (25) goes over the area bounded by the curves LMN and $NB_t A_t$ (Fig. 7), where $B_t A_t$ is the curve $t_{26}^{(-)}(t)$ for given t . Then

$$\rho(s, t) = 4s \int_{C_t K D_t} \frac{ds_{57} dt_{26} \text{Im } f(s_{57}, t_{26})}{\sqrt{K(t, t_{26}, s_{57})}} \quad (27)$$

To evaluate $\text{Im } f(s_{57}, t_{26})$ we turn to the complex s_{67} plane (Fig. 6).

As already mentioned, $\text{Im } f(s_{57}, t_{26})$ arises as a result of the coincidence of the singularities $s_{67}^{(\pm)}$. It is equal to $[f(s_{57}, t_{26} + i\varepsilon) - f(s_{57}, t_{26} - i\varepsilon)]/2i$ and hence, evidently, to the integral along the contour γ of Fig. 6. Thus we have for ρ

$$\rho(s, t) = \frac{4s}{i} \int_{C_t K D_t} \frac{ds_{57} dt_{26}}{\sqrt{K(t, t_{26}, s_{57})}} \int_{s_{67}^{(-)}}^{s_{67}^{(+)}} \frac{ds_{67}}{\sqrt{K(t_{26}, s_{57}, s_{67})}} \quad (28)$$

Up to this point we have proved (28) for the case where the point D_t lies on the curve CE. If the point D_t lies on the curve DE (the curve $t_{26}^{(-)}$ intersects the curve $t_{26}^{(2)}$), the region of integration will include values of t_{26} for which $s_{67}^{(\pm)}$ meet one another for a second time on the real axis to the right of $s_{67}^{(2)}$.

It is easily shown by observing that the square root in (22) changes sign as one goes from $t_{26} < t_{26}^{(1)}$ to $t_{26} > t_{26}^{(2)}$, that $\text{Im } f(s_{57}, t_{26})$ vanishes to the right of the curve ED. Hence formula (28) remains valid also for points D_t lying on the curve ED.

In our investigation of the singularities of the function $f(s_{57}, t_{26})$ we have, up to now, not paid any attention to the fact that the denominator in (22) vanishes for $t_{26} = (\sqrt{s_{57}} \pm m_1)^2$, in which case one of the roots $s_{67}^{(\pm)}$ goes to infinity. If this is the root $s_{67}^{(-)}$, which does not affect the integration contour, the analytic properties of the function $f(s_{57}, t_{26})$ will not be changed. This is the case for

$$(m_5 + m_7) \leq \sqrt{s_{57}} \leq (m_{15}^2 - m_1^2 - m_5^2 + \sqrt{(m_{15}^2 - m_1^2 - m_5^2)^2 - 4m_1^2(m_5^2 - m_7^2)}) / 2m_1; \quad \sqrt{s_{57}} \leq (m_{15}^2 - 2m^2) / m \text{ for } m_t = m. \quad (29)$$

In the opposite case, for $t_{26} = \tilde{t}_{26}$, where

$$\tilde{t}_{26} = (\sqrt{s_{57}} + m_1)^2, \quad (30)$$

the root $s_{67}^{(+)}$ goes to infinity. This root "pinches" the contour of integration, which gives rise to an additional singularity for a given value of t_{26} .

This singularity corresponds to the segment PQ in Fig. 7. It is easily shown that the point P

(the point of coincidence of \tilde{t}_{26} and $t_{26}^{(1)}$) lies always above the tangent point k which determines the singularity of $A_1^{(3)}(s, t)$, and therefore does not affect the equation for the Karplus curve. One might think that each of the singularities of the functions $f(s_{57}, t_{26})$, $t_{26}^{(1),(2)}$; t_{26} should lead to a singularity of $A_1^{(2)}(s, t)$. However, this is not the case. Only the singularity $t_{26}^{(1)}$, which is the first to give rise to a complex $A_1^{(3)}(s, t)$, leads to a singularity of $A_1^{(3)}(s, t)$. We shall discuss this question in detail when we analyze more complicated diagrams. The existence of the singularities $t_{26}^{(2)}$ and \tilde{t}_{26} leads to a change of the region of integration in the integral for ρ [the point C_t in (28) may lie on PQ]. We note that for sufficiently large m_{15}^2 , such that the right hand side of (29) is larger than $(\sqrt{s} - m_6)^2$ [$m_{15}^2 > m(\sqrt{s} + m)$ for $m_1 = m$], the curve PQ lies completely inside the region of integration and does not have any effect at all.

b) Let us now turn to the discussion of the case $m_{15}^2 < (m_1 + m_5)^2$. For such values of m_{15}^2 the curve CED changes from a hyperbola to an ellipse, and the singularities are now located as shown in Fig. 8 (the curve PQ in Fig. 8 corresponds to $t_{26} = \tilde{t}_{26}$). In this case the curve $t_{26}^{(-)}(t)$ ($A_t B_t$) does not meet $t_{26}^{(1),(2)}$ (DEC) in the region of integration for s_{57} . However, the curve CED touches the lower boundary of the region of integration in the point E [$s_{57} = (m_5 + m_7)^2$, $t_{26} = m_1^2 + (m_5 + m_7) \times (m_{15}^2 - m_1^2 + m_5 m_7) / m_5$]. Therefore the integration contour for s_{57} is caught as the curve $t_{26}(t)$ passes through the point E . As a consequence, we obtain the additional region of integration $D_t A_t E$. As t is increased, the points of intersection of $t_{26}^{(-)}(t)$ and $t_{26}^{(1),(2)}$ (DEC), C_t and D_t , approach each other and coalesce for a certain $t = t(s)$ for which the curve $A_t B_t$ touches CDE . As t is further increased, the intersection points become complex. As we shall see, $A_1^{(3)}(s, t)$ is singular for $t = t(s)$.

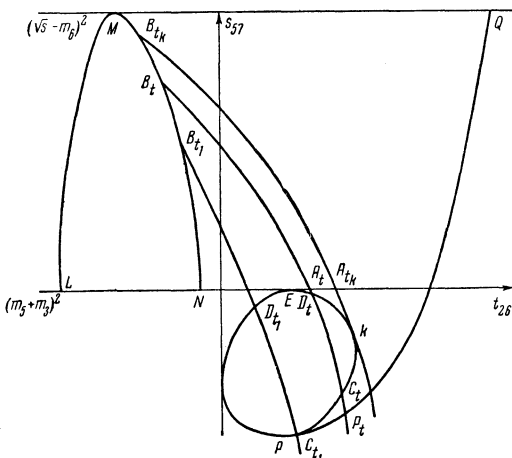

FIG. 8

In order to see this and to calculate $\rho(s, t)$, we shall assume that we have carried out all integrations in (18) except the one over s_{57} , and consider the analytic properties of the resulting integrand $F(s_{57}, t, s)$ in the complex s_{57} plane (Fig. 9). The singularities $s_{57}^{(+)}(t)$ and $s_{57}^{(-)}(t)$ of $F(s_{57}, t, s)$ are determined by the equations $t_{26}^{(-)}(s_{57}, t, s) = t_{26}^{(2)}(s_{57}, s)$ and $t_{26}^{(-)}(s_{57}, t, s) = t_{26}^{(1)}(s_{57}, s)$, respectively. $s_{57}^{(+)}(t_i)$ and $s_{57}^{(-)}(t_i)$ are equal to the ordinates of the points D_i and C_i in Fig. 8. As t is increased, the singularity $s_{57}^{(+)}$ reaches the boundary of the integration contour (the point D_i coincides with the point E) and "catches" it.

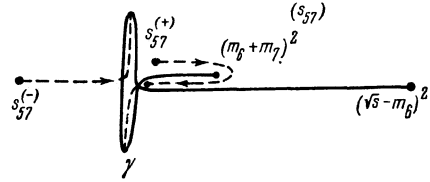

FIG. 9

For $t = t(s)$, $s_{57}^{(+)}$ and $s_{57}^{(-)}$ coincide and recede into the complex plane for $t > t(s)$. It is evident that $A_1^{(3)}(s, t)$ has a singularity for $t = t(s)$ and its imaginary part $\rho(s, t)$ for $t > t(s)$ is the integral along the contour γ' . As is shown in Appendix II, $\rho(s, t)$ can in this case be written in the form

$$\rho(s, t) = \frac{4s}{t} \int_{s_{57}^{(-)}(s, t)}^{s_{57}^{(+)}(s, t)} ds_{57} \int_{t_{26}^{(1)}(s_{57})}^{t_{26}^{(-)}(s, t, s_{57})} \frac{dt_{26}}{\sqrt{K(t, s, t_{26}, s_{57})}} \times \int_{s_{57}^{(-)}(s_{57}, t_{26}, s)}^{s_{57}^{(+)}(s_{57}, t_{26}, s)} \frac{ds_{57}}{\sqrt{K(s_{57}, s_{57}, t_{26}, s)}} \quad (31)$$

It is easily seen that the region of integration in (31) is obtained by analytic continuation of the region of integration in (28), which can also be written in a form analogous to (31).

The integral (31) can be written in a more symmetric form by interchanging the order of integration over t_{26} and s_{57} . Then (31) becomes

$$\rho(s, t) = \frac{4s}{t} \int_{s_{57}^{(-)}(s, t)}^{s_{57}^{(+)}(s, t)} ds_{57} \int_{s_{57}^{(-)}(s, t, s_{57})}^{s_{57}^{(+)}(s, t, s_{57})} ds_{57} \times \int_{t_{26}(s, t, s_{57}, s_{57})}^{t_{26}^{(-)}(s, t, s_{57})} \frac{dt_{26}}{\sqrt{K(s_{57}, t_{26}, s, t) K(s_{57}, s_{57}, t_{26}, s)}} \quad (32)$$

The integral over t_{26} goes from one of the roots of $K(s_{57}, s_{57}, t_{26}, s)$ to one of the roots of

$K(s_{57}, t_{26}, s, t)$. The limits of the integral over s_{67} are

$$s_{67}^{(\pm)}(s, t, s_{57}) = s_{67}^{(\pm)}(s_{57}, t_{26}, s) \Big|_{t_{26}=t_{26}^{(-)}(s, t, s_{57})}$$

It will be shown in the investigation of more complicated diagrams that, taking into account the singularity $t_{26} = t_{26} = (\sqrt{s_{57}} + m_1)^2$, the complex contour of integration for s_{57} in (31) and (32) must be placed to the right of the value of s_{57} given by the ordinate of the point P_{t_i} in Fig. 8.

5. CONCLUSION

A general discussion of our results will be presented in a subsequent article, where we discuss diagrams of a more complicated type. Here we only note that our formulas for $\rho(s, t)$ correspond to Cutkosky's^[2] representation of $\rho(s, t)$ for an arbitrary diagram in the form of a Feynman integral in which some of the internal lines are represented by δ functions of $q_i^2 - m_i^2$, where q_i is the momentum of the i -th line. However, our discussion shows that if the number of integrations in the diagram exceeds the number of δ functions, as is the case for almost all diagrams, this representation must be supplemented by the specification of the region of integration for the remaining variables. This region is solely determined by the analytic continuation of the unitarity condition and has a very complicated shape, including integration along complex contours. Without specification of this region the representation of $\rho(s, t)$ in the form of an integral over δ functions is meaningless.

The three-particle unitarity condition has also been considered in a paper by Lardner.^[4] There it is asserted that the existence of the Mandelstam representation can be proved if the analytic properties of five-point diagrams in only one variable (t_{15} and t_{46} in our notation) are known. Substituting, following Lardner, in the unitarity condition representations in these variables, we obtain the graph considered by us, integrated over dm_{15}^2 and dm_{46}^2 . Lardner asserts that the analytic properties of $A_1^{(3)}(s, t)$, written in the form of the integral (18), can be determined without considering integrations over the variables s_{57} and s_{67} , and that these variables can be regarded as constant parameters (like m_{15}^2 and m_{46}^2) in the analytic continuation. Our discussion shows that this is not the case. If we did not integrate over s_{57} and s_{67} , the function $A_1^{(3)}(s, t)$ would have complex singularities, which actually do not exist owing to the change in the contours for s_{57} and s_{67} in the analytic continuation.

APPENDIX I

If the masses are different, the expressions used in the main body of the paper take the form

$$4s \cdot 4p_1^2 p_5^2 p_6^2 K(z_{15}^0, z_{56}^0, -z_{26}) = [t_{26}^2 - 2(s_{57} + m_1^2)t_{26} + (s_{57} - m_1^2)^2] (s_{67} - s_{67}^{(+)})(s_{67} - s_{67}^{(-)}), \quad (\text{AI.1})$$

$$\begin{aligned} s_{67}^{(\pm)} = & [t_{26}^2 - 2(s_{57} + m_1^2)t_{26} + (s_{57} - m_1^2)^2]^{-1} \{s_{57}^2 (m_{15}^2 + m_2^2) \\ & + s_{57} [-st_{26} + t_{26}(2m_1^2 - m_5^2 - m_2^2 - m_{15}^2)] \\ & + s(m_7^2 - m_{15}^2) + m_5^2 m_6^2 - m_5^2 m_7^2 - m_1^2 m_6^2 \\ & - m_2^2 (m_1^2 + m_5^2 + m_7^2) - 2m_{15}^2 (m_1^2 + m_6^2 - 2m_2^2) \\ & + st_{26}^2 + m_5^2 t_{26}^2 - st_{26} (m_{15}^2 + m_1^2 + m_7^2 - 2m_5^2) \\ & - t_{26} [(m_5^2 + m_7^2)(m_1^2 + m_6^2) + (m_5^2 - m_7^2)m_5^2 - m_6^2 m_{15}^2] \\ & + m_1^2 s (m_{15}^2 + m_7^2 - 2m_5^2) \\ & - m_1^2 [m_6^2 (m_{15}^2 + m_5^2 - 2m_7^2) - m_1^2 (m_6^2 + m_7^2) \\ & - m_2^2 (m_5^2 - m_7^2)] \\ & \pm 2m_1 \sqrt{s(t_{26} - t_{26}^{(1)})(t_{26} - t_{26}^{(2)})(t_{26} - t_{26}^{\prime}) (t_{26} - t_{26}^{\prime\prime})}, \end{aligned} \quad (\text{AI.2})$$

$$\begin{aligned} t_{26}^{(1),(2)} = & (1/2m_5^2) \{2m_5^2 (m_1^2 + s_{57}) \\ & + (m_{15}^2 - m_1^2 - m_6^2) (s_{57} + m_5^2 - m_7^2) \\ & \pm ([s_{57} - (m_5 + m_7)^2] [s_{57} - (m_5 - m_7)^2] \\ & \times [m_{15}^2 - (m_1 + m_5)^2] [m_{15}^2 - (m_1 - m_5)^2]^{1/2}\}, \end{aligned} \quad (\text{AI.3})$$

$$\begin{aligned} t_{26}^{\prime\prime} = & (1/2s) \{2s (m_6^2 + m_2^2) \\ & + (s_{57} - s - m_6^2) (s + m_2^2 - m_1^2) \\ & \pm ([s - (m_1 + m_2)^2] [s - (m_1 - m_2)^2] \\ & \times [s - (\sqrt{s_{57}} + m_6)^2] [s - (\sqrt{s_{57}} - m_6)^2]^{1/2}\}. \end{aligned} \quad (\text{AI.4})$$

The expressions for $t_{26}^{(1),(2)}$ and $t_{26}^{\prime\prime}$ are equal to the two roots of the Landau determinants^[5] for the triangular diagrams of Figs. 10, a and b, respectively.

Furthermore,

$$\begin{aligned} 4s \cdot 4p_2^2 p_4^2 p_6^2 K(z, z_{26}, z_{46}^0) = & [s - (m_3 + m_4)^2] \\ & \times [s - (m_3 - m_4)^2] [t_{26} - t_{26}^{(+)}(t)] [t_{26} - t_{26}^{(-)}(t)], \end{aligned} \quad (\text{AI.5})$$

$$\begin{aligned} t_{26}^{(\pm)}(t) = & -(1/2s) [s^2 - s(m_1^2 + m_2^2 + m_6^2 + s_{57}) \\ & + (m_2^2 - m_1^2)(m_6^2 - s_{57}) \\ & + [2sm_{46}^2 + s^2 - s(m_3^2 + m_4^2 + m_6^2 + s_{57}) + (m_4^2 - m_3^2)(m_6^2 - s_{57})] \\ & \times \frac{[2st + s^2 - s(m_1^2 + m_2^2 + m_3^2 + m_4^2) + (m_2^2 - m_1^2)(m_4^2 - m_3^2)]}{2s [s - (m_3 + m_4)^2] [s - (m_3 - m_4)^2]} \\ & \pm \frac{2m_4 [s(t - t^{(1)}(s))(t - t^{(2)}(s))(s_{57} - s_{57}^{\prime})(s_{57} - s_{57}^{\prime\prime})]^{1/2}}{[s - (m_3 + m_4)^2] [s - (m_3 - m_4)^2]}. \end{aligned} \quad (\text{AI.6})$$

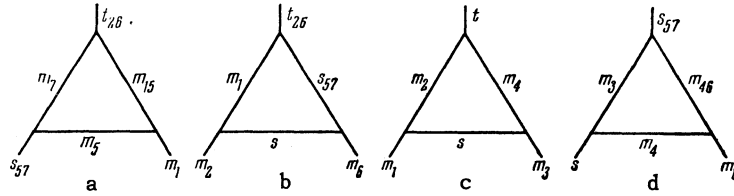

FIG. 10

$t^{(1),(2)}(s)$ and s_{57}'' are again the roots of the Landau determinants for the triangular diagrams of Figs. 10, c and d, respectively. They are obtained from (AI.3) and (AI.4) by a simple change of indices.

Finally, we quote the formula for the boundary of the region of integration for s_{67} and s_{57} , i.e., the condition $|z_{56}^0| \leq 1$. It follows from the expression

$$4\rho_5^2 \rho_6^2 (z_{56}^0 - 1) = s^{-1} \{s [s_{56} m_7^2 + s_{57} m_6^2 + s_{67} m_5^2 - 2m_5^2 m_6^2 - 2m_5^2 m_7^2 - 2m_6^2 m_7^2] + m_5^2 m_6^2 s_{56} + m_5^2 m_7^2 s_{57} + m_6^2 m_7^2 s_{67} - 2m_5^2 m_6^2 m_7^2 - s_{56} s_{67} s_{57}\};$$

$$s_{56} + s_{67} + s_{57} = s + m_5^2 + m_6^2 + m_7^2. \quad (\text{AI.7})$$

APPENDIX II

We indicate the derivation of (31). We have

$$\rho(s, t) = [A_1^{(3)}(s, t + i\varepsilon) - A_1^{(3)}(s, t - i\varepsilon)]/2i. \quad (\text{AII.1})$$

For the discontinuity we only need consider the region of integration for t_{26} and $s_{57} \leq (m_5 + m_7)^2$ (region EDt_1At_1 in Fig. 8). The integral over this region before the coincidence of $s_{57}^{(+)}(t)$ and $s_{57}^{(-)}(t)$ [$t < t(s)$] can be written in the form

$$4s \int_{s_{57}^{(+)}(t)}^{(m_5+m_7)^2} ds_{57} \{F(t, s, s_{57} - i\varepsilon) - F(t, s, s_{57} + i\varepsilon)\}. \quad (\text{AII.2})$$

$F(s_{57} \pm i\varepsilon)$ are the values of the function F on different branches of the cut belonging to the singularity $s_{57}^{(+)}(t)$. Furthermore,

$$F(t, s, s_{57} - i\varepsilon) - F(t, s, s_{57} + i\varepsilon) = \int_{t^{(1)}(s_{57})}^{t^{(-)}(s_{57}, t)} \frac{dt_{26}}{\sqrt{K(t, t_{26}, s_{57})}} \{f(t_{26} - i\varepsilon, s_{57}) - f(t_{26} + i\varepsilon, s_{57})\}. \quad (\text{AII.3})$$

In order to obtain the value of the difference $f(t_{26} - i\varepsilon, s_{57}) - f(t_{26} + i\varepsilon, s_{57})$ in the region EDt_1At_1 , it is easiest to consider the analytic continuation of (21) into the region $s_{57} < (m_5 + m_7)^2$. We continue the resulting function in the form of a contour integral to values $t_{26} > t_{26}^{(1)}(s_{57})$, circumventing the singularities in such a way as to make the difference vanish up to values $t_{26} = t_{26}^{(1)}(s_{57})$. As a result we obtain

$$f(t_{26} - i\varepsilon) - f(t_{26} + i\varepsilon) = -2 \int_{s_{57}^{(-)}}^{s_{57}^{(+)}} \frac{ds_{67}}{\sqrt{K(s_{67}, t_{26}, s_{57})}}$$

($\sqrt{K} > 0$). Substituting (AII.2) and (AII.3) in (AII.1), we obtain (31).

- ¹ S. Mandelstam, Phys. Rev. **112**, 1344 (1958).
- ² R. Cutkosky, J. Math. and Phys. **1**, 429 (1960).
- ³ S. Mandelstam, Phys. Rev. Lett. **1**, 84 (1960).
- ⁴ R. W. Lardner, Nuovo cimento **19**, 77 (1961).
- ⁵ L. D. Landau, Nucl. Phys. **13**, 181 (1959).

Translated by R. Lipperheide