

ANOMALOUS SCATTERING AND PHASE FOCUSING OF A MODULATED ELECTRON BEAM IN A PLASMA

M. D. GABOVICH and V. P. KOVALENKO

Physics Institute, Ukrainian Academy of Sciences

Submitted February 3, 1969

Zh. Eksp. Teor. Fiz. 57, 716-724 (September, 1969)

It is shown that the anomalous scattering of an electron beam in a plasma can be explained by introducing an initial velocity modulation of the electrons. The anomalous scattering of both modulated and unmodulated beams may be explained if the plasma-beam interaction and the klystron bunching are taken into account simultaneously.

THE phenomenon of anomalous scattering of a relatively slow electron beam in the plasma, which was discovered by Langmuir^[1] and investigated for more than 40 years^[2-8], consists of angular scattering of the electrons, loss of their energy, and formation of anomalously fast electrons at a certain distance from the cathode, in a sharply bounded spatial region distinguished by a characteristic glow (meniscus). It is universally admitted that the anomalous scattering is connected with the excitation of plasma oscillations by the electron beam, but many aspects of this phenomenon remain puzzling to this day.^[9] In particular, it is not clear whether the klystron effect, which is connected with possible modulation of the beam on the plasma boundary in a layer adjacent to the cathode, plays any role^[6,9]. The following arguments were advanced against the idea that this effect plays a role in the phenomenon under consideration: strong oscillations in the layer next to the cathodes are not always observed; a theoretical estimate of the amplitude of these oscillations^[10] has led to a value much lower than the value kT_e/e which follows from^[9]; the laws connecting the coordinate of the meniscus with the different parameters do not agree to the conclusions of the simple kinematic theory of phase focusing of the beam^[11].

The purpose of the present paper was to ascertain the possibility of duplicating the effect of anomalous scattering with the aid of artificial modulation of the beam velocity on the plasma boundary, and to describe more precisely the mechanism of this phenomenon on the basis of an investigation of the singularities of the bunching of electrons in the plasma.

EXPERIMENTAL SETUP

The electron source was an electron-bombarded boride-lanthanum cathode 1 (Fig. 1). The electron beam was shaped in the region between the first grid of the grounded resonator 3 and the cathode, the negative potential of which U_0 determined the electron energy. The electron velocity was modulated in gap 4 between two tungsten grids of the resonator, which was excited with the aid of a GSS-12 resonator. The width of gap 4 was 0.2-0.3 mm, the mesh of the grids being 0.13 mm. The accelerated and velocity-modulated electron beam entered chamber 6, which had glass walls and grounded end electrodes, where it interacted

with the plasma produced by it. The necessary working gas (argon) pressure (usually 5×10^{-4} - 10^{-2} mm Hg) was maintained in the chamber.

The excited oscillations were investigated with the aid of a probe 7 that could be moved along and across the beam. The signal from the probe was applied to the input of the S4-5 spectrum analyzer. The analysis of the longitudinal velocities of the electrons was by means of a movable analyzer 8, and oscillography of the energy spectrum of the beam electron was with the aid of sawtooth voltage generator 11. When the modulation amplitude was measured with the analyzer, the latter was moved to within 1-2 cm from the modulating grid.

FORMATION OF MENISCUS AND ANOMALOUS SCATTERING OF ELECTRONS IN THE MODULATED BEAM

Under definite conditions, it is possible to observe the anomalous scattering, as usual, without resorting to artificial modulation of the beam (Fig. 2a); an increased-brightness zone in the beam, which is sharply delineated on the cathode side, is characteristic of discharges of the meniscus type^[5]. It turns out that if a modulating voltage is applied under these conditions, then the sharply delineated meniscus comes closer to the cathode and the distance to the meniscus decreases with increasing modulating voltage (Figs. 2b, c).

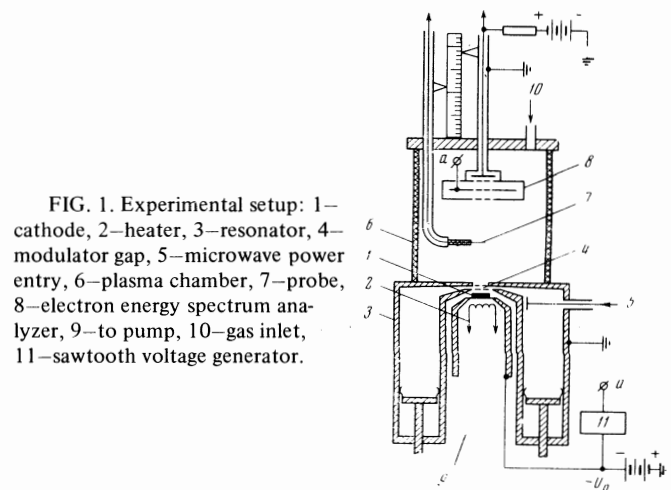

FIG. 1. Experimental setup: 1—cathode, 2—heater, 3—resonator, 4—modulator gap, 5—microwave power entry, 6—plasma chamber, 7—probe, 8—electron energy spectrum analyzer, 9—to pump, 10—gas inlet, 11—sawtooth voltage generator.

It is known that if certain conditions connected with the gas pressure, electron energy, and the current strength are not satisfied, then no anomalous scattering is observed and the beam can cover appreciable distances without significant modification (Figs. 2d and 3a). It turns out that modulation of the beam can cause in these cases the appearance of a meniscus and angular scattering of the electrons (Figs. 2e and 3b-d). Depending on the conditions (gas pressure, current, beam energy, modulation frequency), the outward appearance of the scattering zone was altered, but whenever this zone existed within the confines of the discharge chamber, it was always more or less clearly localized and approached the cathode with increasing modulation amplitude.

Figure 4 shows oscillograms that present the deceleration characteristics of the electron beam upon modulation (curve 1) and in the absence of beam modulation (curve 2). These oscillograms were obtained with the aid of the analyzer 8 (Fig. 1) under conditions such that there was no meniscus in the absence of modulation, and in the presence of modulation the meniscus was in front of the analyzer. Comparison of oscillograms 1 and 2 indicates that the modulation leads to the appearance of anomalously rapid electrons, which are characteristic of the phenomenon under consideration, and whose energy, expressed in equivalent volts, greatly exceeds the sum of the accelerating potential difference U_0 and the initial-modulation amplitude U_1 .

The distribution of the intensity of the microwave oscillations detected by the probe has a clearly pronounced maximum at the location of the meniscus (Fig. 5). The foregoing facts show that with the aid of initial modulation of the beam it is possible to produce artificially a characteristic glowing region, namely a meniscus with maximum amplitude of the excited microwave oscillations, accompanied by angular scattering and energy loss of the beam electrons and by appearance of anomalously fast electrons; in other words, it can cause a phenomenon identical with anomalous scattering observed usually when an unmodulated artificial beam propagates.

PHASE FOCUSING OF ELECTRON BEAM IN A PLASMA

The simple kinematic theory of phase focusing of

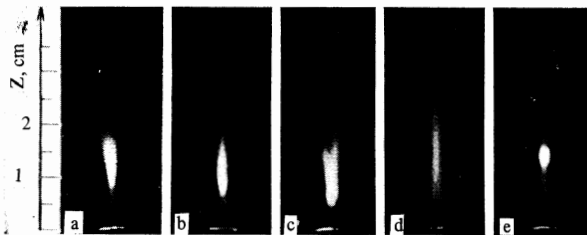

FIG. 2. Appearance of the beam in "natural" and "artificial" anomalous scattering: a— $U_1 = 0$, $U_0 = 70$ V, $I_0 = 12.5$ mA, $p \approx 5 \times 10^{-3}$ mm Hg; b— $U_1 = 4$ V, $f = 800$ MHz, the remaining conditions unchanged; c— $U_1 = 8$ V, $f = 800$ MHz, remaining conditions unchanged; d— $U_1 = 0$, $U_0 = 150$ V, $I_0 = 8$ mA, $p \approx 7 \times 10^{-3}$ mm Hg; e— $U_1 = 19$ V, $f = 765$ MHz, the remaining conditions as in Fig. 2d.

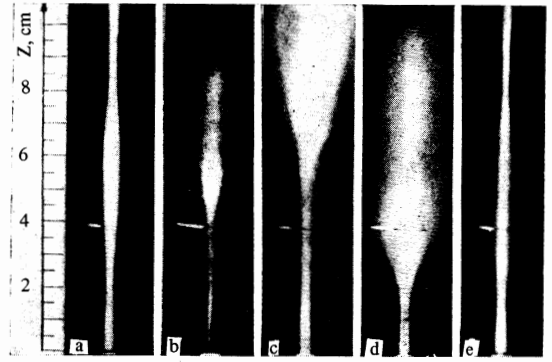

FIG. 3. Appearance of the beam at different modulation frequencies and amplitudes; $U_0 = 110$ V, $H_0 = 5$ mA, $p \approx 1.5 \times 10^{-3}$ mm Hg; a— $E_1 = 0$; b— $f = 270$ MHz, $U_1 = 0.8$ V; c— $f = 340$ MHz, $U_1 = 0.2$ V; d— $f = 340$ MHz, $E_1 = 12$ V; e— $f = 625$ MHz, $E_1 = 26$ V.

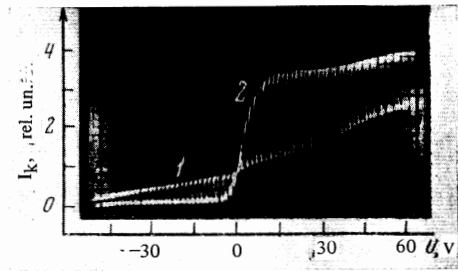

FIG. 4. Deceleration characteristics of the beam following modulation—(oscillogram 1) and in the absence of modulation (oscillogram 2); $U_0 = 110$ V, $I_0 = 5$ mA, $p \approx 1.5 \times 10^{-3}$ mm Hg, $f = 285$ MHz, $E_1 = 2.3$ V.

the electrons leads to the following expression for the distance to the phase focus

$$S_k = 2U_0v_0 / U_1\omega, \quad (1)$$

where U_1 is the modulation amplitude and v_0 is the dc component of the beam velocity. In the derivation of (1) no account was taken of the change in the electron velocities over the entire path of beam propagation, which may be caused by the interaction between the electron beam and the plasma. Using the results of the linear theory of plasma-beam interaction, we can obtain an expression for S , which takes the indicated velocity change into account.

The variable values of the electric field, electron velocity, and beam current density are expressed as follows^[12]:

$$E = Ce^{i(\omega t - kz)}, \quad (2)$$

$$v = \frac{1}{i} \frac{e}{m} \frac{E}{\omega - kv_0}, \quad (3)$$

$$j = 4\pi \frac{1}{i} \frac{\omega_0^2 \omega E}{(\omega - kv_0)^2}, \quad (4)$$

where $\omega_0 = \sqrt{4\pi n_0 e^2 / m}$ is the natural frequency of the beam. Considering for simplicity a cold plasma, we can obtain from the corresponding dispersion equation

$$\frac{\Omega^2}{\omega^2} + \frac{\omega_0^2}{(\omega - kv_0)^2} = 1 \quad (5)$$

the following expression for k ,

$$k_{1,2} = \frac{\omega}{v_0} \pm \frac{\omega_0}{v_0 [1 - (\Omega/\omega)^2]^{1/2}}, \quad (6)$$

where $\Omega = \sqrt{4\pi e^2 n/m}$ is the plasma frequency.

The boundary conditions in the case of an infinitesimally narrow modulating gap ($z = 0, v = v_1 e^{i\omega t}, j = 0$) make it possible to determine from (3) and (4) the arbitrary constant C and to obtain expressions for the velocity of the electrons that pass through the modulating gap at the instant t_0 and arriving at the coordinate z . We have

$$v(z) = v_0 + v_1 \cos \beta z \cos \omega t_0 \quad \text{if } \Omega < \omega, \quad (7)$$

$$v(z) = v_0 + 1/2 v_1 (e^{\gamma z} + e^{-\gamma z}) \cos \omega t_0 \quad \text{if } \Omega > \omega. \quad (8)$$

Here

$$\gamma = \frac{\omega_0}{v_0 [(\Omega/\omega)^2 - 1]^{1/2}}, \quad (9)$$

$$\beta = \frac{\omega_0}{v_0 [1 - (\Omega/\omega)^2]^{1/2}}. \quad (10)$$

Using, as usual, the expression for the charge conservation

$$j(z) dt_z = j_0 dt_0, \quad t_z = t_0 + t_{tr}, \quad t_{tr} = \int_0^z \frac{dz}{v(z)},$$

where t_{tr} is the electron transit time from the point $z = 0$ to the point z , and also the expressions (7) and (8) under the assumption that the increment of the velocity in the entire path is much lower than v_0 , we can obtain expressions for the current density:

$$j(z) = j_0 \left[1 + \frac{U_1 \omega \sin \beta z}{2 U_0 v_0 \beta} \sin \omega t_0 \right] \quad \text{if } \Omega < \omega, \quad (11)$$

$$j(z) = j_0 \left[1 + \frac{U_1 \omega \operatorname{sh} \gamma z}{2 U_0 v_0 \gamma} \sin \omega t_0 \right] \quad \text{if } \Omega > \omega. \quad (12)$$

When $\Omega = 0$ expression (11) goes over into the well known expression for the conduction current in vacuum with allowance for the space charge of the beam^[13]. The influence of the plasma in this case ($\Omega < \omega$) reduces to replacement of the natural frequency of the beam ω_0 by a certain higher effective frequency $\omega_0/\sqrt{1 - (\Omega/\omega)^2}$; thus, the plasma, by intensifying the effect of the Coulomb repulsion of the produced electron bunches, hinders the phase focusing.

In the case $\Omega > \omega$ we obtain from (12) an equation for the determination of the coordinate S of the phase focus:

$$e^{\gamma S} - e^{-\gamma S} = 2\gamma S k. \quad (13)$$

At sufficiently large γS , we obtain

$$S \approx \gamma^{-1} \ln 2\gamma S k. \quad (14)$$

The quantity S turns out to be smaller than S_k . This is connected with the fact that the electrons that obtain a velocity increment on passing through the modulator will continue to be accelerated all the time (see expression (8)), while the electrons decelerated in the modulator will continue to slow down. Thus, the distance within which some electrons overtake the others decreases.

The dashed lines in Fig. 6 show the trajectories of the electrons as given by the kinematic theory for certain conditions under which the phase focus is produced at a distance of 4.5 cm. from the modulator, and also the trajectories calculated with the aid of formula (8), corresponding to $\gamma = 1.2 \text{ cm}^{-1}$. From a comparison of these trajectories we see how appreciably the phase focus should change as a result of the interaction of the electron beam with the plasma.

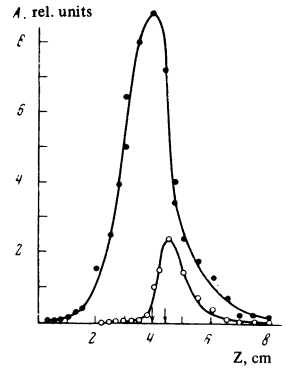

FIG. 5. Distribution of oscillation intensity along the beam: ●—first harmonic, $f = 300 \text{ MHz}$; ○—second harmonic, $f = 600 \text{ MHz}$, $E_1 = 110 \text{ V}$, $I_0 = 4.5 \text{ mA}$, $p \approx 1.5 \times 10^{-3} \text{ mm Hg}$. The arrows denote the boundaries of the meniscus.

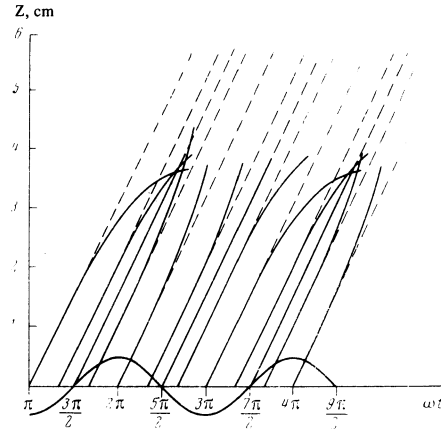

FIG. 6. Space-time diagrams constructed in accordance with the kinematic theory (dashed line) and with allowance for the interaction between the beam and the plasma (solid lines).

CONNECTION BETWEEN ANOMALOUS SCATTERING AND PHASE FOCUSING

Figure 7 shows the experimental points which demonstrate the dependence of the positions of the meniscus on the modulation amplitude at different beam current and gas pressures. The dashed lines showed the dependence of the phase focus on this amplitude, as determined from formula (1). As expected from the foregoing analysis, there is no correspondence between the position of the meniscus and the position of the phase focus calculated by formula (1). This is particularly obvious at small modulation amplitudes. To verify whether the position of the meniscus corresponds to the phase focus calculated by formula (14), Fig. 7 shows also curves plotted in accordance with this formula for three values of γ , namely 0.82, 1.15, and 1.5 cm^{-1} . It is seen that the position of the meniscus is described satisfactorily by formula (14), i.e., it coincides with the position of the phase focus calculated with allowance for the interaction between the beam and the plasma. A certain deviation of the experimental points from the calculated curves at large amplitudes U_1 may be connected with the fact that the approximations used in the derivation of (14) are not applicable here. The values of γ presented above differ somewhat from those calculated by formula (9), namely 1.1, 1.8, and 2.0 cm^{-1} ; this is not surprising, since the beam has actually a limited cross section, the plasma electron temperature differs from zero, etc.

The good agreement between the phase focus and the position of the meniscus is also convincingly evidenced by the following comparison, in which the calculated values of γ are not needed. Fig. 8 shows the dependence of the quantity $\eta = \log(U_{1z}/U_{10})$ on the coordinate z , where U_{1z} is the modulation amplitude measured by the analyzer 8 (Fig. 1) at a distance z , and U_{10} is the amplitude of the modulation at the point $z = 0.2$ cm. Using (8), it is possible to obtain from the slope of this curve, at not too small values of z , the value $\gamma = 1.57$ cm⁻¹. Formula (14) with this value of γ leads to $S = 4.6$ cm, whereas the distance to the meniscus measured under the same conditions is 4 cm.

Figures 9 and 10 show the experimentally obtained dependences of the meniscus position on the beam-accelerating potential difference and on the modulation frequency, and also the corresponding differences constructed in accordance with formula (14). The comparison of these data also leads to the conclusion that the position of the meniscus coincides with the position of the phase focus. The appreciable discrepancy between the experimental and calculated data at high frequencies (Fig. 10) is connected with the fact that when ω approaches the plasma frequency Ω formula (9) becomes highly inaccurate (the plasma frequency is in this case ≈ 800 MHz). In the case of modulation at frequencies higher than the plasma frequency, under the condition that

$$\frac{0.5U_1\omega\sqrt{1-(\Omega/\omega)^2}}{U_0\omega_0} < 1,$$

no phase focus is produced at all, in accordance with expression (11). Nor is the anomalous scattering effect observed in this case, as is evidenced by Fig. 3e.

We have established in the present experiment the abundance of higher harmonics in the spectrum of the oscillations observed in the meniscus, both for a modulated and an unmodulated beam. This circumstance, on

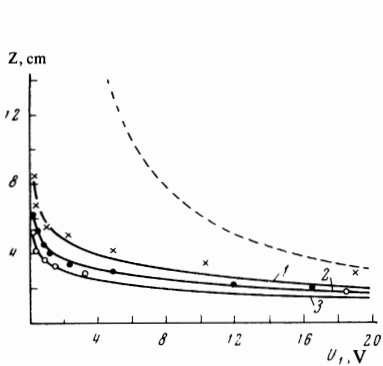

FIG. 7

FIG. 7. Dependence of the positions of the phase focus and of the meniscus on the modulation amplitude, $U_0 = 120$ V, $f = 400$ MHz. Curve 1—position of phase focus calculated from formula (14) at $\gamma = 0.82$ cm⁻¹; 2—the same at $\gamma = 1.15$ cm⁻¹, 3—the same at $\gamma = 1.5$ cm⁻¹; dashed—position of phase focus in accordance with the kinematic theory. X—position of meniscus at $I_0 = 2.8$ mA, $p \approx 3 \times 10^{-3}$ mm Hg; ●—the same at $I_0 = 8$ mA, $p \approx 1.5 \times 10^{-3}$ mm Hg; ○—the same at $I_0 = 9$ mA, $p \approx 1 \times 10^{-3}$ mm Hg.

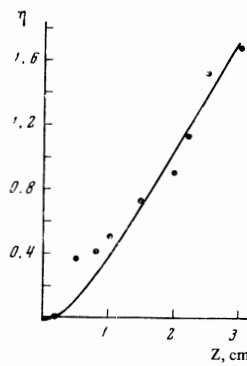

FIG. 8

FIG. 8. Dependence of the value of η on the distance to the modulator, $U_0 = 120$ V, $I_0 = 9.5$ mA, $p \approx 1.5 \times 10^{-3}$ mm Hg, $U_1 = 0.7$ V, $f = 360$ MHz.

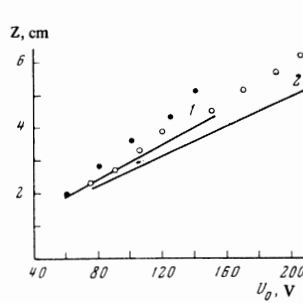

FIG. 9

FIG. 9. Dependence of the calculated position of the phase focus (solid lines) and of the experimentally established position of the meniscus (points) on the beam energy: $p \approx 10^{-3}$ mm Hg, $f = 400$ MHz, $U_1 = 0.65$ V, Curve 1, ●— $I_0 = 6$ mA; curve 2, ○— $I_0 = 8$ mA.

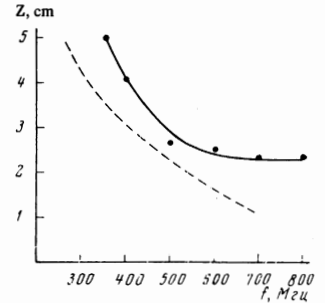

FIG. 10

FIG. 10. Dependence of the calculated position of the phase focus (dashed) and of the experimentally established meniscus position on the modulation frequency: $U_0 = 110$ V, $I_0 = 55$ mA, $p \approx 2 \times 10^{-3}$ mm Hg, $U_1 = 3.5$ V.

the one hand, indicates that actually the beam is strongly bunched in the place determined by formula (14), i.e., the phase focus is located there, and on the other hand it confirms once more the similarity between the phenomena in both cases.

CONCLUSIONS

It is shown in the present paper that by initially modulating the beam it is possible to duplicate the phenomenon of anomalous scattering. It is shown that the position of the anomalous-scattering zone coincides with the position of the phase focus, which, as a result of interaction between the electron beam and the plasma, is located closer to the modulator than would follow from the kinematic theory of bunching of electrons in a vacuum. The analyzed influence of the plasma on the bunching of the electrons in the case $\Omega > \omega$ leads to the conclusion that the efficiency of a klystron can be increased by producing a plasma in its bunching space.

A comparison of the anomalous scattering of an artificially modulated beam with the "natural" anomalous scattering indicates that the same phenomenon, in which a role is played by the klystron mechanism, is involved in both cases. The features of phase focusing of electrons in the plasma, demonstrated in the present article, lead to the conclusion that when the amplitude of the initial modulation is estimated, in the case of a "natural" anomalous scattering, it is necessary to take into account the spatial amplification of the oscillations. In the case of appreciable amplification, the initial modulation may turn out to be much smaller than the value that follows from the simple kinematic theory of phase focusing.

This eliminates the objections raised in the introduction against the role of klystron mechanism in the phenomenon of "natural" anomalous scattering. This phenomenon is connected with the initial modulation of the electron beam, which leads to a succeeding bunching of the electrons under conditions of their continuous acceleration or deceleration in the fields produced on

the path of the beam in the plasma that interacts with the beam.

The task of further research is to clarify in detail the phenomena occurring in the meniscus itself.

The authors are grateful to Ya. B. Fainberg for interest in the work and for a discussion of its results.

(1959)].

⁷M. D. Gabovich, *Radiotekhn. i élektron.* **6**, 178 (1961).

⁸K. G. Emeleus, *Advances in Electronics and Electron Physics*, No. 4, Acad. Press. (1964), p. 59.

⁹A. A. Vlasov, *Teoriya mnogikh chastits (Many-particle Theory)*, Gostekhizdat, 1950.

¹⁰Yu. A. Romanov and G. F. Filippov, *Zh. Eksp. Teor.* **40**, 123 (1961) [*Sov. Phys.-JETP* **13**, 87 (1961)].

¹¹A. A. Zaitsev and I. A. Savchenko, *Prikl. mekh. i tekhn. fiz.* No. 2, 30 (1965).

¹²I. A. Akhiezer and Ya. B. Faïnberg, *Zh. Eksp. Teor. Fiz.* **21**, 1262 (1951).

¹³V. Ya. Savel'ev, *Zh. Tekh. Fiz.* **10**, 1365 (1940).

Translated by J. G. Adashko

81

¹I. Langmuir, *Phys. Rev.* **26**, 585 (1925).

²I. Merril and W. Webb, *Phys. Rev.* **55**, 1191 (1939).

³G. Wehner, *J. Appl. Phys.* **22**, 761 (1951).

⁴T. R. Neil and K. G. Emeleus, *Proc. Roy. Irish Acad.* **53**, 197 (1951).

⁵T. K. Allen, R. A. Bailey, and K. G. Emeleus, *Brit. J. Appl. Phys.* **6**, 320 (1955).

⁶M. D. Gabovich and L. L. Pasechnik, *Zh. Eksp. Teor. Fiz.* **36**, 1025 (1959) [*Sov. Phys.-JETP* **9**, 727