

## ISOMAGNETIC DISCONTINUITY IN A COLLISIONLESS SHOCK WAVE

V. G. ESELEVICH, A. G. ES'KOV, R. Kh. KURTMULLAEV, and A. I. MALYUTIN

Institute of Nuclear Physics, Siberian Department of the U.S.S.R. Academy of Sciences

Submitted October 28, 1970

Zh. Eksp. Teor. Fiz. 60, 2079-2091 (June, 1971)

Results of an investigation of the microstructure of a collisionless shock front are presented. The investigation is performed by means of special probes with high spatial resolution. It is found that at Mach numbers exceeding a certain critical value  $M_{C1} \approx 2.8-3$  a narrow region is formed in the transition layer. In a practically stationary magnetic field, the potential experiences a sharp jump (isomagnetic discontinuity) in this region. The width  $\delta$  of the region is apparently of the order of several Debye radii  $r_D$ . Further increase of the Mach number leads to the disappearance of the discontinuity at  $M = M_{C2} \sim 4.5-5.5$ . It is suggested that the appearance of the isomagnetic jump is connected with the formation of an electrostatic ion-acoustic wave in the transition layer. The cause of this phenomenon is a nonlinear slope increase which cannot be compensated by dissipative front broadening at  $M > M_{C1}$ . Disappearance of the jump at  $M \approx M_{C2}$  is apparently due to reflection of some of the ions by the front and is similar to destruction of a strong electrostatic wave at large Mach numbers. Destruction of the isomagnetic discontinuity, which is accompanied by formation of a multiple-velocity plasma flow, can be interpreted naturally as breaking of the shock wave.

## INTRODUCTION

**EXPERIMENTS** on collisionless shock waves in a rarefied plasma show that the character of the flow and the turbulent processes in the shock transition are sensitive to the Mach number  $M$  ( $M = u/v_A$ ,  $u$  is the wave velocity,  $v_A = H_0/\sqrt{4\pi n_0 m_i}$  is the Alfvén velocity in the initial plasma). In particular, it was noted as far back as in 1965<sup>[1,2]</sup> that starting with values  $M = 3$  and above, a qualitative change takes place in the profile of the magnetic field (a forward-elongated "pedestal" appears, and the transition layer broadens). Additional information was obtained after performing a series of experiments with simultaneous sounding of the magnetic field  $H$  and the plasma concentration  $n$  in the wave front.<sup>[3]</sup> It was established in these measurements that in definite plasma shock flow regimes, the character of the distribution of the parameters inside the front changes qualitatively, namely, a tendency is observed towards establishment of a "discontinuous" distribution of the concentration at a relatively smooth variation of the magnetic field. This phenomenon, called the "isomagnetic jump," agrees with the hypothesis advanced in the theory that breaking of strong shock waves in a plasma is possible when, with increasing slope, the wave front passes through the stage of discontinuous density distribution.<sup>[4]</sup> What was left open, however, was the question whether the observed jumplike distribution of the concentration is only a short intermediate phase prior to the wave breaking, or whether it is a stable structure that is conserved as the wave moves.

The noted phenomenon of the isomagnetic jumps in a collisionless shock front has an analog in gasdynamics. We have in mind the isothermal jump that can arise under certain conditions in a shock wave in a gas.<sup>[5]</sup> An analogous phenomenon was predicted theoretically also for the gas of a collisional shock wave in a dense plasma (see, for example, <sup>[6]</sup>).

Among the experiments pointing to a critical dependence of the state of the plasma in the transition layer on

the Mach number, one should include microfield measurements, which have shown that the occurrence of the pedestal correlates with changes in the spectrum of the electromagnetic fluctuations.<sup>[7]</sup>

In recent work on the determination of the ion-velocity distribution function<sup>[8]</sup> it was observed that the described rearrangement of the magnetic structure of the front is accompanied by increased ion heating, whereas the opposite tendency was established earlier for the component.<sup>[9]</sup>

The totality of all these and other data gives grounds for stating that the character of plasma flow in a shock transition, the structure of the front, and the type and nature of the dissipation undergo qualitative changes at certain critical Mach numbers. The relation between these phenomena and their physical basis still remains unclear, however.

One can hardly expect to solve such a problem by further accumulation of averaged characteristics of the transition layer. From this point of view, the most vital need at present is for qualitative improvement of the measurement technique, aimed at attaining spatial and temporal resolutions sufficient for the registration of the minimal characteristic scales of a collisionless plasma, and the establishment of the temporal correlation of the processes inside the transition layer. Such an attempt was made in the present investigation.

## APPARATUS AND DIAGNOSTICS

The experiments were performed with the UN-4 setup.<sup>[7,10]</sup> In different cases we used hydrogen, helium, or argon plasmas which were produced with the aid of an induction discharge in a cylindrical volume of 16 cm diameter. The concentration of the initial plasma  $n_0$  was set in the range  $10^{13}-10^{15}$  cm<sup>-3</sup>, the intensity of the initial quasistationary magnetic field was  $H_0 = 100-2000$  Oe. A cylindrical shock wave was excited by a magnetic piston by discharging a capacitor into a surge coil.

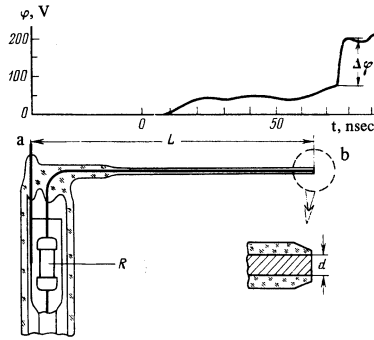

FIG. 1. Diagram of electric probe.

For the diagnostics we used magnetic and electric probes, with the aid of which we determined the distributions of the magnetic field and of the electric potential in the front of the shock wave.

To register the magnetic field we used open-loop magnetic probes, and also special probes with high spatial resolution, a description of which is given in [10].

The electric probe, a diagram of which is shown in Fig. 1, was intended to measure the potential of the electric field in the wave. To attain maximum spatial resolution in the radial direction, the electrode b was made in the form of a flat surface oriented parallel to the wave front and coinciding with the section plane of the glass insulator, so that the finite dimensions of the construction did not limit the resolution of the probe in the direction of the radial coordinate. The electrode a was placed on the axis of the system and served to provide a reference to the potential ahead of the wave front ( $\varphi = 0$ ). The resistance  $R$  built into the probe was intended to limit the current drawn from the plasma, and ranged from 0.2 to 8 kilohms in the experiments, depending on the purpose of the probe. Namely, in those cases when good temporal resolution of the probe was needed, and also a sufficiently high signal level, which is usually needed when high-frequency recording apparatus is employed, we used resistances  $R = 0.2-0.3 \text{ k}\Omega$ . In measurements of the absolute value of the potential, the resistance  $R$  was increased to 6–8  $\text{k}\Omega$ . The distance  $L$  between the electrodes ranged from 2 to 4 cm, the area of the gathering surface of electrode b was  $s = 10^{-3}-10^{-2} \text{ cm}^2$ .

Each probe electrode acquired, during the course of the measurement, a potential due to the local state of the plasma and, generally speaking, different from the spatial potential of the plasma. Therefore the level of the signal from the probe differed from the measured potential difference by an amount that can be regarded as the measurement error. In the concrete scheme used in the present investigation, during the course of the entire quasistationary phase of the process up to the cumulation instant, the potential of the axial electrode a was  $\varphi_a \approx 0$  owing to the low electron temperature of the initial plasma ( $T_{e0} = 0.5-2.0 \text{ eV}$ ). We can therefore confine ourselves to consideration of the phenomena near the electrode b during the passage of the shock wave past this electrode, when the potential behind the front increases to a value  $\varphi = \varphi_2$ .

Neglecting edge effects, the ion current to the flat electrode can be written in the form

$$I_i = snev,$$

where  $v$  is the plasma velocity relative to the probe. We disregard here the thermal motion of the ions, since in the main their thermal velocity is  $v_i \ll v$ . For the electronic component, to the contrary, the thermal motion is the principal effect, which determines the electron current

$$I_e = -snev\sqrt{T_e/2\pi m_e} \exp(e\delta\varphi/T_e).$$

Here  $\delta\varphi$  is the difference between the plasma potential and the electrode potential. The total probe current is

$$I = sne[v - \sqrt{T_e/2\pi m_e} \exp(e\delta\varphi/T_e)].$$

Assuming that this current is sufficiently small, we obtain the two components of which the error is made up: the floating potential

$$(\delta\varphi)_p = -\frac{T_e}{2e} \ln \frac{T_e}{2\pi m_e v^2} \quad (1)$$

and the voltage drop across the resistance  $r_p$  of the plasma-probe transition layer

$$(\delta\varphi)_p = -\ln \frac{T_e}{snev^2} \quad (1)$$

An analysis of expression (1) together with the experimental  $T_e(M)$  dependence [9] has shown that the quantity  $(\delta\varphi)_f/\varphi_2$  remains in the range 0.1–0.2 in the greater part of the investigated interval of values of  $M$ , reaching a maximum value of 0.3 near  $M = 2.5$ . In fact, the error can be much smaller if account is taken of the presence of the magnetic field and of the secondary emission of the electrons from the surface of the probe. It is clear that the quantity  $(\delta\varphi)_f/\varphi_2$  is determined by the state of the plasma (i.e., in final analysis, by the Mach number), whereas the voltage drop  $(\delta\varphi)_p$  can be made negligibly small by decreasing the current drawn from the plasma and by increasing the electrode area  $s$ . For example, for an electrode of 0.3 mm diameter, ( $s = 7 \times 10^{-2} \text{ cm}^2$ ) and a resistance  $R = 3.5 \text{ k}\Omega$ , the ratio  $(\delta\varphi)_p/\varphi_2$  in a hydrogen plasma is less than 10% for all the Mach numbers and for all the employed concentrations ( $n_0 \gtrsim 5 \times 10^{13} \text{ cm}^{-3}$ ).

The Mach number of the shock wave was calculated from the formula  $M = (u/H_0) \sqrt{4\pi n_0 m_1}$ , using the measured values of the wave velocity  $u$ , the initial concentration  $n_0$ , and the magnetic field  $H_0$ . The systematic error in the value of  $M$  determined in this manner did not exceed 15%.

## EXPERIMENTAL RESULTS

The investigation procedure reduced mainly to registration of the magnetic and electric fields simultaneously at two radially separated points  $r_1$  and  $r_2$ . This yielded, by the same token, the distribution of the quantities  $H$  and  $\varphi$  in the transition layer, the evolution of the front at a distance  $\Delta r = r_1 - r_2$ , i.e., the degree of its stationarity, and finally the propagation velocity of the shock wave. These data were obtained by successively varying the initial state of the plasma in the indicated Mach-number range from 1.3 to 6.

At relatively small values of  $M$ , the front has an aperiodic monotonic character, and the distributions of the potential and of the magnetic field  $\Delta H = H - H_0$  are

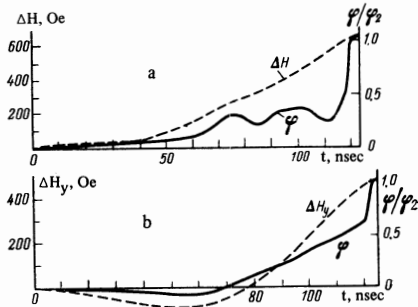

FIG. 2. Isomagnetic potential jump in transverse (a) and oblique (b) shock waves: a— $M = 4$ ,  $H_0 = 330$  Oe,  $n_0 = 2 \times 10^{14}$   $\text{cm}^{-3}$ , helium; b— $M = 2.5$ ,  $H_0 = 310$  Oe,  $n_0 = 7.5 \times 10^{13}$   $\text{cm}^{-3}$ ,  $\theta = 20^\circ$ , hydrogen.

qualitatively similar. In [10] there is a detailed investigation of the shock front at Mach numbers  $M < 2.5$ , with emphasis on features of the occurrence of instability and the mechanism of saturation of the turbulence.

A qualitatively different behavior of the potential is observed when the Mach number becomes larger than a certain critical value  $M_{C1} = 2.8-3$ . At  $M > M_{C1}$  there is observed on the crest of the wave a sharp peak in the profile of the potential, in the form of a jump with width  $\delta$  much smaller than the width  $\Delta$  of the magnetic profile (Fig. 2a). The magnetic field remains practically unchanged over the width  $\delta$ , so that the observed jump is isomagnetic. Experiments have shown that the isomagnetic jump is formed in a wide range of initial parameters  $n_0$  and  $H_0$ , in hydrogen, helium, or argon plasma, and that its amplitude depends only on the Mach number.

The qualitative similarity of the phenomenon is retained also in shock waves propagating at an angle to the magnetic field. Figure 2b shows an oscillogram obtained in an oblique wave at  $\theta = 20^\circ$  and  $M = 2.5$  ( $\theta$  is the angle between the direction of the magnetic field and the plane of the front). With changing angle, however, definite differences from the case  $\theta = 0$  appear. In a transverse wave, near the Mach number  $M_{C1}$ , a change is observed in the profile of the magnetic field  $H$  (broadening of the signal, appearance of a pedestal). In the earlier experiments, [11] this was precisely the attribute according to which the critical Mach number was introduced. The relation between this phenomenon and the isomagnetic jump will be examined in detail later on, but it must be emphasized even now that in an oblique wave the formation of the potential jump occurs with conservation of the oscillatory structure of the front. A tendency towards establishment of a monotonic  $H(x)$  distribution is observed at much larger Mach numbers. In other words, the occurrence of a potential jump and the transformation of the magnetic profile differ in their physical nature, and it is therefore necessary to distinguish between the effects themselves as well as between the characteristic Mach numbers at which they take place.

The discrepancy between the calculated  $M_{C1}(\theta)$  dependence given in [12] and the experimental curve of [11] is apparently due to the fact that different critical Mach numbers were investigated in these studies.

The isomagnetic jump was investigated in greatest

detail in a transverse wave, so that the exposition that follows pertains to this case.

Experiments on the isomagnetic jump can be grouped as follows: 1) measurement of the width of the isomagnetic jump; 2) determination of the dependence of the jump amplitude  $\Delta\phi$  on the Mach number; 3) establishment of the limits of existence of the isomagnetic jump (in terms of the Mach number); 4) the study of other phenomena accompanying the isomagnetic jump, such as, for example, the change of the total value of the potential  $\phi_2$  behind the wave front, and the pedestal on the profile of the magnetic field.

1) Measurements of the time width of the jumps on the oscillograms obtained with the aid of the described electric probes have shown that in the presence of a certain statistical scatter, the minimum value of  $\tau$  is 1–1.5 nsec, which is at the limit of the bandwidth of the transmitting circuitry ( $f_0 \lesssim 1$  GHz). The observation results therefore make it possible only to estimate the upper limit of the width of the jump, which in our case amounts to  $u\tau \sim 2 \times 10^{-2}$  cm ( $u \lesssim 2 \times 10^7$  cm/sec).

For a correct comparison of the width of the jump and the characteristic scales of the magnetized plasma, it is necessary that the values of the limiting spatial and temporal resolutions be smaller than the characteristic scales in the plasma (the Debye radius  $r_D$  and the respective values of  $r_D/u$ ). In hydrogen, under typical experimental conditions ( $n_0 > 5 \times 10^{15}$   $\text{cm}^{-3}$ ), this requirement cannot be satisfied, but in the case of heavy gases the problem becomes simpler, since  $r_D/u \propto \sqrt{m_i/n_0}$ . In addition, owing to the large mass of the ions, it is possible to generate shock waves at relatively low concentrations. The width of the isomagnetic jump observed in an argon plasma,  $2 \times 10^{-2}$  cm, turned out to be of the same order as the Debye radius. This result indicates that the mechanism forming the isomagnetic jump ensures establishment of an equilibrium width of the jump  $\delta$  up to scales on the order of the Debye radius.

It is important to note that the considered structure of the shock wave with isomagnetic jump is repeated in the experiments with good reproducibility. Simultaneous registration of the potential at two points radially separated by 10–15 mm has shown that such a structure remains unchanged as the wave moves. These facts point to the possible existence of a stationary shock wave with an isomagnetic jump.

2) Further increase of the Mach number ( $M > M_{C1}$ ) is accompanied by a growth of the relative value of the isomagnetic jump of the potential  $\Delta\phi$ . As seen from Fig. 3, the value of  $\Delta\phi/\phi_2$  reaches a maximum value  $(\Delta\phi/\phi_2)_{\text{max}} \approx 0.5$  at  $M = 4.5$ . (To reduce the influence of the nonstationarity factor, the curve was plotted by using only oscillograms for which the relation  $M = h(h+5)/2(4-h)$ , which is valid for a stationary shock wave, was satisfied with sufficient accuracy. Here  $h = H_2/H_0$ .)

3) As seen from Fig. 3, the region of existence of the isomagnetic jump is limited with respect to the Mach number not only from below but also from above. The lower limit corresponded to the critical Mach number  $M_{C1}$ , and the upper to  $M_{C2}$ . The noticeable scatter of the points in the region  $4.5 < M < 5.5$  may be connected with the fact that the critical  $M_{C2}$  is sensitive to

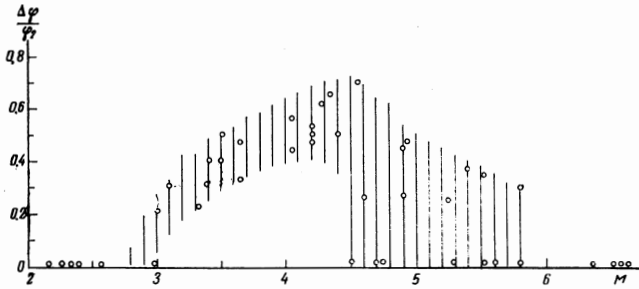

FIG. 3. Dependence of the relative amplitude of the isomagnetic jump on the Mach number. Hydrogen.

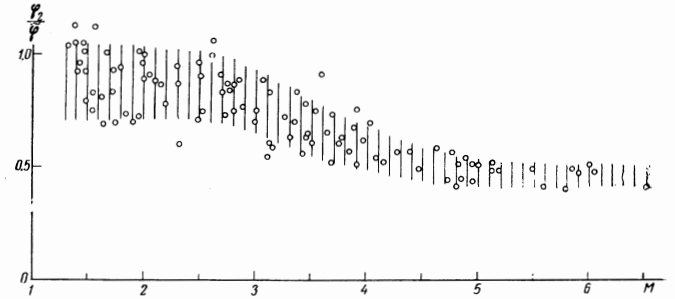

FIG. 5. Dependence of the relative magnitude of the potential behind the wave front on the Mach Number. Hydrogen.

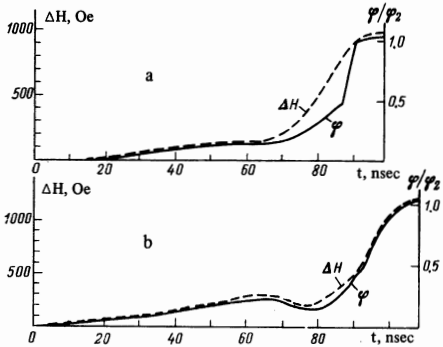

FIG. 4. Formation of pedestal and destruction of the isomagnetic jump: a— $M = 4$ ,  $H_0 = 300$  Oe,  $n_0 = 3.4 \times 10^{14}$  cm $^{-3}$ , hydrogen; b— $M = 5$ ,  $H_0 = 250$  Oe,  $n_0 = 2.1 \times 10^{14}$  cm $^{-3}$ , hydrogen.

the initial parameters of the plasma (for example, to the value of  $T_i/T_e$ ), and the scatter of these parameters can lead to a "smearing" of the upper limit of the region of existence of the isomagnetic jump.

When  $M > M_{C2}$ , the front of the potential again becomes gently sloping and similar to the front of the magnetic field, but its width is larger by approximately one order of magnitude than the shock-front width measured at small Mach numbers (Fig. 4b).<sup>1)</sup>

4) An interesting regularity is observed in the behavior of the level of the potential  $\phi_2$  behind the wave front when the Mach number is varied. It was already noted earlier<sup>[7]</sup> that at large Mach numbers  $\phi_2$  decreases in comparison with

$$\frac{m_i u^2}{2e} \left( 1 - \frac{1}{h^2} \right) \equiv \bar{\phi},$$

and approaches  $\bar{\phi}/2$ . At the same time, at small values of  $M$  in the case of a resistive dissipation mechanism,  $\phi_2$  is close to  $\bar{\phi}$ . It is seen from Fig. 5 that the section in which the ratio  $\phi_2/\bar{\phi}$  changes from 0.8–1 to 0.5 occurs in the interval  $M_{C1}-M_{C2}$ .

It is important to note that the potential drop behind the front of the wave correlates with a deformation of the magnetic profile (the appearance of a pedestal, broadening), which at  $M > M_{C1}$  can no longer be described within the framework of the resistive model, as was done in<sup>[10]</sup>.

These and a number of other facts (for example, the

<sup>1)</sup>We note that at higher initial densities, when the wave is stationary over scales on the order of  $c/\Omega_0$ , monotonic, "smeared-out" profiles of  $H$  and  $\phi$  with width  $\Delta \sim c/\Omega_0$  are observed at  $M > M_C$ .

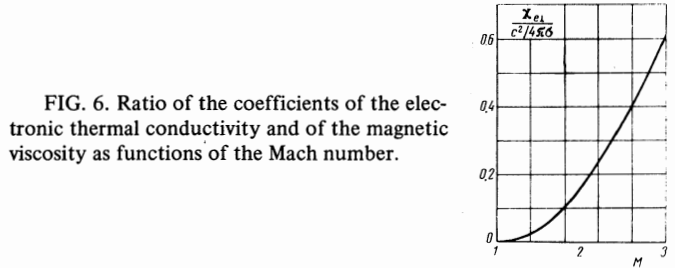

FIG. 6. Ratio of the coefficients of the electronic thermal conductivity and of the magnetic viscosity as functions of the Mach number.

increase of the ionic heating in the region  $M > M_{C1}$ <sup>[9]</sup>) indicate that when  $M > M_{C1}$  there is another mechanism in the front, besides the resistive friction, leading to dragging of the ions and to their heating. This mechanism is apparently due to the collective interactions in the collisionless plasma, and it can be regarded as an effective ion viscosity.

Let us stop to discuss, finally, the influence of the errors of the electric probes on the form of the experimental plots (Figs. 3 and 5). The dependence of  $\Delta\phi/\phi_2$  on  $M$  was determined from measurements of the potential with electric probes having resistances  $R = 200-400$  ohms. The main cause of the error is in this case the underestimate of  $\phi_2$  compared with the true value, owing to the presence of a floating potential and a finite resistance  $r_p$  of the transition layer. As a result, the position of the experimental curve turns out to be too high within limits determined by the error in the measurements of the potential  $\phi_2$ . For the same reason, the position of the curve on Fig. 6 is too low, but to a lesser degree, since the probes used in the corresponding experiments had  $R = 6-8$  k $\Omega$  and the influence of the resistance  $r_p$  was practically eliminated.

DISCUSSION OF RESULTS

Nature of isomagnetic jump. As already noted, at sufficiently small Mach numbers the main dissipative mechanism in the shock-wave front is resistive friction. It is known, however, that at  $M = 2.76$  the resistive front becomes unstable against an unlimited increase of the slope of the density profile. The existence of an equilibrium shock transition at  $M > 2.76$  is possible only if, besides the resistive dissipation, there act in the transition layer other mechanisms that effectively counteract the increase of the slope of the density front. From this point of view, it is natural to assume that the experimentally observed tendency towards establishment

of a discontinuous distribution of the potential is due to the nonlinear increase of the slope, and the existence of a stationary structure with an isomagnetic jump is the result of the action of some new mechanism that leads to broadening of the profile of  $\varphi$ . Such a mechanism can presumably be the electronic thermal conductivity, ion viscosity, or dispersion of ion sound.

The effective frequency of the electron-ion collisions  $\nu_{\text{eff}}$  in a turbulent plasma determines both the conductivity and the electronic thermal conductivity. Therefore it is possible to compare these two types of dissipation and to ascertain the role of the electronic thermal conductivity in the formation of the front structure. The corresponding magnetic-viscosity and thermal coefficients are expressed in terms of  $\nu_{\text{eff}}$  in the following manner:<sup>[13]</sup>

$$\eta_m = \frac{c^2}{4\pi\sigma} = \frac{m_e c^2}{4\pi n e^2} \nu_{\text{eff}}, \quad \chi_{e\perp} = \frac{2T_e m_e c^2}{e^2 H} \nu_{\text{eff}}.$$

Hence  $\chi_{e\perp}/\eta_m = 8\pi n T_e / H^2$ .

Figure 6 shows a plot of  $\chi_{e\perp}/\eta_m$  behind the shock-wave front against the Mach number. As seen from the plot, when  $M \gtrsim M_{C1}$  we have  $\chi_{e\perp}/\eta_m \gtrsim 0.4$ , i.e., in a strong wave the contribution of the thermal conductivity to the dissipation is appreciable. It is clear at the same time that the electronic thermal conductivity cannot be the mechanism stabilizing the isomagnetic jump, for in this case its width  $\delta_\chi$  would be of the order of  $\chi_{e\perp}/u$ , i.e., it would amount to 30–40% of the total width of the front, whereas the experimentally observed width of the isomagnetic jump  $\delta$  can be smaller than 0.01  $\Delta$ .

The obtained experimental data<sup>[14]</sup> and the results of theoretical investigations on shock transitions with turbulent ion viscosity<sup>[15]</sup> are presently insufficient to explain, on the basis of this model, the existence of an isomagnetic jump, its evolution, and its destruction with increasing Mach number.

A more realistic model is the representation proposed in<sup>[16]</sup>, wherein the isomagnetic jump has a dispersion character. In this case the jump is a nonlinear electrostatic wave, and the effect compensating for the nonlinear increase of the slope of the front is the dispersion of the ion sound. Favoring such a model is the fact that the existence of ion-acoustic shock waves has by now been proved experimentally and confirmed by results of a numerical simulation with an electronic computer.<sup>[17, 18]</sup> It was established in these investigations that laminar electrostatic waves exist only in a definite range of Mach numbers  $M_S$ , which depends strongly on the ion temperature ( $M_S = v_S \sqrt{m_i / T_e}$ , where  $v_S$  is the velocity of the electrostatic wave). When a certain critical Mach number value  $M_S = M_S^*$  is reached, the electrostatic wave is destroyed by reflection of some of the ions from the front of the potential. It can be assumed that this effect takes place also in the isomagnetic jump of a magnetosonic wave; this explains the vanishing of the jump at  $M = M_{C2}$ . The width of the front of an isomagnetic jump with a dispersion structure should be of the same order as the Debye radius  $r_D$ , a fact that does not contradict the experimental results of the present paper.

Numerical simulation with a computer, carried out in<sup>[12]</sup> for the case of an oblique shock wave, confirms the possible existence of an electrostatic isomagnetic jump.

Thus, within the framework of the assumptions made, the observed phenomena can be explained qualitatively in the following manner.

In the region of small values of  $M$ , the main mechanism of dissipation in the shock front is turbulent resistance, and at  $M > 2.5$  some contribution is made also by the electronic thermal conductivity. The density profile is similar to the magnetic-field profile in accordance with the MHD model of the resistive front. With increasing Mach number, the velocity of the ion-acoustic oscillations  $c_{S2}$  behind the front increases, approaching the plasma velocity  $v_2$  (in the system of the wave); simultaneously, an increase takes place in the slope of the density profile. This phenomenon, however, does not lead at large  $M$  to a destruction of the laminar flow of the plasma (wave breaking), since dispersion of the ion sound comes into play at scales on the order of the Debye radius. As a result, at  $M = M_{C1}$ , the growth of the slope stops and an isomagnetic jump of the density and of the potential is produced. This instant corresponds to satisfaction of the equality  $c_{S2} = v_2$ . In essence, the jump is an electrostatic shock wave with a width equal to several Debye radii; its relative amplitude  $\Delta\varphi/\varphi_2$  is determined by the Mach number and increases with increasing  $M$ .

An important effect influencing the structure of the transition layer and the region of existence of the isomagnetic jump is the reflection of some of the ions from the front of the potential, occurring as a result of the thermal scatter of the ion velocities. As is well known, this effect is the cause of the destruction of electrostatic waves of large amplitude.<sup>[19]</sup> In our case the isomagnetic jump is destroyed at  $M = M_{C2}$  for the same reason. Together with the destruction of the jump, there vanishes the mechanism that restrains the unlimited growth of the slope, as a result of which the shock wave breaks. In the laboratory system, this is expressed in the fact that the ions from the side of the piston overtake the front, greatly disturbing the single-velocity flow of the plasma. The front of the potential then becomes gently sloping, and approaches in shape the profile of the magnetic field (Fig. 4b).

It is difficult at present to describe exhaustively the processes occurring in a shock wave with  $M > M_{C2}$ . The available experimental data indicate that besides resistive friction, an important role in dissipative processes inside the transition layer is played by the effective ion viscosity, which results from the presence of multivelocity flow of the plasma.<sup>[7]</sup>

An interesting effect observed simultaneously with the isomagnetic jump is the formation of the so-called "pedestal" on the profiles of the magnetic field and the potential (Fig. 4a). It is most natural to attribute this effect to reflection of some of the ions from the wave front in the presence of a finite ion temperature. In a quantitative analysis of this phenomenon (see, for example, <sup>[19]</sup>), it must be borne in mind that the ions in the front have, in all probability, an essentially non-Maxwellian velocity distribution.<sup>[20]</sup> Most of them are at a temperature close to the temperature of the initial plasma, and only a small fraction (10–20%) is heated to a temperature close to  $T_e$ .

It is curious that the Mach number at which the pedestal becomes noticeable is close to  $M_{C1}$ . However, the

aggregate of the experimental and theoretical data still does not give grounds for stating that formation of the pedestal is a consequence of the appearance of the isomagnetic jump.

**Estimate of critical Mach numbers.** Under the assumptions made above, the Mach number  $M_{C1}$  that corresponds to the occurrence of the isomagnetic jump can be determined from the equation  $c_{S2} = v_2$ , where  $c_{S2} = \sqrt{(T_{e2} + \gamma_i T_{i2})/m_i}$ . At  $T_i = 0$  this equation yields  $M_{C1} = 3.46$ . Allowance for the finite ion temperature leads to a decrease of  $M_{C1}$ . For example, at  $(T_i/T_e)_2 \equiv \alpha_2 = 0.15$  we can obtain  $M_{C1} = 3.12$  (for  $\gamma_i = 3$ ).

It should be noted that the distribution functions of the ions and electrons in the plasma behind the wave front are apparently far from Maxwellian by virtue of the specific nature of the turbulent heating.<sup>[20]</sup> It is therefore difficult to expect exact correspondence between the quantity obtained in this manner and the experimental value of the critical Mach number  $M_{C1}$ . Nonetheless, this calculation is useful, since it gives an idea of the degree of dependence of  $M_{C1}$  on the parameter  $\alpha$ .

Calculation of the second critical Mach number is a much more complicated problem. The main difficulty lies here in the determination of the state of the plasma ahead of the isomagnetic jump and in a correct allowance for the influence of the reflected ions. We present here the simplest calculation of the stationary problem under the essential assumption that the electrons and ions have Maxwellian distributions on both sides of the isomagnetic jump.

We choose a reference frame connected with the wave, and let the indices  $s$  and  $2$  pertain to points ahead of and behind the jump, respectively.

As a result of the good electronic thermal conductivity, we can assume that the temperature of the electrons remains unchanged over the width of the isomagnetic jump (this is equivalent to satisfaction of the inequality  $\chi_{e\perp} \gg r_{D\perp}$ ). Then there should exist ahead of the jump a heat flux  $q_{es}$  directed towards the initial plasma,

$$q_{es} = -\left(\chi_{e\perp} \frac{\partial T_e}{\partial x}\right)_s.$$

From the heat-transfer equation for the electrons

$$nT_e \frac{dS_e}{dt} = \text{div}(\chi_e \nabla T_e)$$

we can obtain by integration

$$q_{es} = n_0 u T_{es} (S_{e2} - S_{es}).$$

Here  $S_e$  is the entropy per electron. Since  $S_e \propto \ln n$  at  $T_e = \text{const}$ , it follows that

$$q_{es} = -n_0 u T_{es} \ln(v_s/v_2).$$

We write down the equations for the conservation of the momentum and energy fluxes on the isomagnetic jump, retaining as a parameter the ratio  $(T_i/T_e)_s = \alpha_S$ :

$$\begin{aligned} m_1 n_1 v_s^2 + n_s T_{es} (1 + \alpha_s) &= m_1 n_2 v_2^2 + n_2 (T_{e2} + T_{i2}), \\ m_1 n_1 v_s \left[ \frac{v_s^2}{2} + \frac{\gamma}{\gamma - 1} \frac{T_{es}}{m_i} (1 + \alpha_s) \right] + q_{es} &= \\ = m_1 n_2 v_2 \left[ \frac{v_2^2}{2} + \frac{\gamma}{\gamma - 1} \frac{T_{e2} + T_{i2}}{m_i} \right]. \end{aligned}$$

FIG. 7. Connection between the Mach number  $M_S$  of the electrostatic wave and the Mach number  $M$  of the shock wave for the cases  $T_i = 0$  (curve 1) and  $(T_i/T_e)_S = 0.1$  (curve 2).

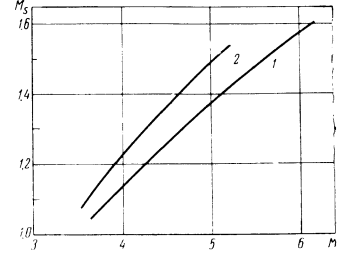

These equations determine the electron temperature and the plasma velocity ahead of the isomagnetic jump. For the normalized velocity  $w = v_S/v_2$  we obtain the equation

$$w^2 - \frac{2\gamma}{\gamma + 1} (1 + f)w + 2 \frac{\gamma - 1}{\gamma + 1} (1 + f - w) \frac{w \ln w}{1 + \alpha_s} + \frac{2\gamma}{\gamma + 1} f + \frac{\gamma - 1}{\gamma + 1} = 0,$$

where  $f = (h - 1)^3 / (h + 5)$ ,  $h = H_2/H_0$ .

The electron temperature is given by the expression

$$T_{es} = \frac{m_i v_2^2}{1 + \alpha_s} w (1 + f - w).$$

Calculating from this  $v_S(M)$  and  $T_{es}(M)$ , we can determine the Mach number of the electrostatic wave  $M = v_S \sqrt{m_i/T_{es}}$  as a function of  $M$ . Figure 7 shows a plot of  $M_S(M)$  for  $\gamma = 5/3$  and two values of  $\alpha_S$ : curve 1 for  $\alpha_S = 0$  and curve 2 for  $\alpha_S = 0.1$ . In the case of cold ions ( $\alpha_S = 0$ ) the critical number  $M_S^*$ , as is well known, is 1.6. This yields  $M_{C2} = 6.2$ . The presence of a finite ion temperature greatly decreases the value of  $M_S^*$  and accordingly of  $M_{C2}$ . For  $\alpha_S = 0.1$  we have  $M_S^* = 1.3$ ,<sup>[18]</sup> which leads to  $M_{C2} = 4.3$ .

We see from this result that the critical Mach number is very sensitive to the ion temperature. In the experiments performed in a wide range of initial parameters, the ratio  $T_i/T_e$  did not remain constant, since, depending on the regime, the initial ion temperature and the conditions for turbulent heating of the plasma were varied. This apparently led to a noticeable scatter of the points on the  $\Delta\phi/\phi_2$  plot (Fig. 4) in the region  $M \sim M_{C2}$ .

For the reasons indicated above, the results of the calculation of the value of  $M_{C2}$  require caution when a comparison is made with experiment, but they can serve as an illustration of the phenomenon and a basis for qualitative conclusions.

## CONCLUSION

The main result of the present work was an experimental observation of the isomagnetic jump in the front of a collisionless shock wave and the determination of the region of the Mach-number values in which this jump exists. We estimated the width of the jump and investigated the dependence of its amplitude on the Mach number. It is shown that in the range  $M_{C1} < M < M_{C2}$  the "discontinuous" distribution of the concentration in the front is stable, and that with increasing Mach number of the wave this state precedes directly the breaking of the front at  $M = M_{C2}$ . A hypothesis is advanced concerning the nature of the isomagnetic jump (electrostatic ion-acoustic wave), and an estimate of the critical Mach numbers  $M_{C1}$  and  $M_{C2}$  is made on the basis of the corresponding model.

The authors are grateful to R. Z. Sagdeev for valuable discussions and to V. Krasov for help with the work.

<sup>1</sup>R. Kh. Kurtmullaev, Yu. E. Nesterikhin, V. I. Pil'skii, and R. Z. Sagdeev, 11 Mezhdunarodnaya konferentsiya po fizike plazmy (11th Intern. Conf. on Plasma Physics), Culham, 1965, Paper CN 21/218.

<sup>2</sup>J. W. M. Paul, L. S. Holmes, M. J. Parkinson, and J. Sheffield, *Nature* **208**, 133 (1965).

<sup>3</sup>R. Kh. Kurtmullaev, V. L. Masalov, K. I. Mekler, and V. I. Pil'skii, *ZhETF Pis. Red.* **7**, 65 (1968) [*JETP Lett.* **7**, 49 (1968)].

<sup>4</sup>R. Z. Sagdeev, *Voprosy teorii plazmy (Problems of Plasma Theory)*, vol. 4, Atomizdat, 1964, p. 20; A. A. Galeev and R. Z. Sagdeev, *Lectures on the Non-linear Theory of Plasma*, Trieste, September, 1966.

<sup>5</sup>L. D. Landau and E. M. Lifshitz, *Mekhanika sploshnykh sred (Fluid Mechanics)*, Gostekhizdat, 1953 [Addison-Wesley, 1958].

<sup>6</sup>V. D. Shafranov, *Zh. Eksp. Teor. Fiz.* **32**, 1453 (1957) [*Sov. Phys.-JETP* **5**, 1183 (1957)].

<sup>7</sup>A. G. Es'kov, R. Kh. Kurtmullaev, A. I. Malyutin, V. I. Pil'skii, and V. N. Semenov, *ibid.* **56**, 1480 (1969) [*29*, 793 (1969)].

<sup>8</sup>N. I. Alinovskii, A. T. Altyntsev, and N. A. Koshilev, *Issledovanie nagreva ionnoi komponenty plazmy besstolknovitel'noi udarnoi volnoi (An Investigation of the Heating of the Ion Component of a Plasma by a Collisionless Shock Wave)*, *Nuc. Phys. Inst. Preprint 5-71*, Novosibirsk, 1971.

<sup>9</sup>R. Kh. Kurtmullaev, V. I. Pil'skii, and V. N. Se-

menov, *Zh. Tekh. Fiz.* **40**, 1044 (1970) [*Sov. Phys.-Tech. Phys.* **15**, 804 (1971)].

<sup>10</sup>V. G. Eselevich, A. G. Es'kov, R. Kh. Kurtmullaev, and A. I. Malyutin, *Zh. Eksp. Teor. Fiz.* **60**, 1658 (1971) [*Sov. Phys.-JETP* **33**, No. 5 (1971)].

<sup>11</sup>R. Kh. Kurtmullaev, Paper at 11th Intern. Conf. on Collisionless Shock Waves in a Plasma, Frascati, Italy, June, 1969.

<sup>12</sup>A. E. Robson, *Collision-Free Shocks in the Laboratory and Space*, Proc. Study Group ESRIN, Frascati, June 1969, p. 159.

<sup>13</sup>S. I. Braginskii, *Voprosy teorii plazmy (Problems of Plasma Theory)*, Vol. 1, Atomizdat, 1963, p. 205.

<sup>14</sup>H. K. Andersen, S. A. Andersen, V. O. Jensen, P. Nilsen, and N. D'Angelo, *Phys. Fluids* **13**, 1106 (1970).

<sup>15</sup>D. A. Tidman, *Phys. Fluids* **10**, 547 (1967).

<sup>16</sup>R. Z. Sagdeev, Paper at 11th Intern. Conf. on Collisionless Shock Waves in a Plasma, Frascati, Italy, June 1969.

<sup>17</sup>R. J. Taylor, D. R. Baker, and H. Ikezi, *Phys. Rev. Lett.* **24**, 206 (1970).

<sup>18</sup>S. G. Alikhanov, V. G. Belan, G. N. Kichigin, and P. Z. Chebotaev, *Zh. Eksp. Teor. Fiz.* **59**, 1961 (1970) [*Sov. Phys.-JETP* **32**, 1061 (1962)].

<sup>19</sup>L. C. Woods, *J. Plasma Phys.* **3**, 435 (1969).

<sup>20</sup>G. E. Vekshtein and R. Z. Sagdeev, *ZhETF Pis. Red.* **11**, 297 (1970) [*JETP Lett.* **11**, 194 (1970)].

Translated by J. G. Adashko  
226