

Dispersion of thermomagnetic waves in bismuth

V. N. Kopylov

Institute of Solid State Physics, USSR Academy of Sciences

(Submitted 27 June 1979)

Zh. Eksp. Teor. Fiz. 78, 198–205 (January 1980)

The results of a study of thermomagnetic waves [L. E. Gurevich and B. L. Gel'mont, *Sov. Phys. JETP* 19, 604 (1964); 24, 124 (1967). V. N. Kopylov, *JETP Lett.* 28, 121 (1978)] in bismuth at helium temperatures are presented. In the absence of a static magnetic field, the dispersion law for the waves is determined by the Nernst-Ettingshausen coefficient and by the temperature gradient in the medium. The investigation of the propagation of thermomagnetic waves together with static measurements on the same specimens made it possible to compare the observed dispersion law with the theoretical dispersion equation. It is found that the current theory is in quite satisfactory agreement, both qualitatively and quantitatively, with the results of the present experiments.

PACS numbers: 72.15.He

INTRODUCTION

In 1964, Gurevich and Gel'mont predicted that low-frequency electromagnetic waves of a new type might propagate in metals; they called the new waves "Thermomagnetic waves," since their propagation is due to the Nernst-Ettingshausen thermomagnetic effect, which leads to the interaction of the magnetic field of the wave with the drift motion of the carriers that results from the action of the temperature gradient.¹

The dispersion law for these waves is obtained by solving the Maxwell equations

$$\operatorname{rot} \mathbf{E} = -\frac{1}{c} \frac{\partial \mathbf{H}}{\partial t}, \quad \operatorname{rot} \mathbf{H} = \frac{4\pi}{c} \mathbf{j}, \quad \operatorname{div} \mathbf{H} = 0 \quad (1)$$

simultaneously with the material equation

$$\mathbf{E} = \rho \mathbf{j} + \alpha_0 \nabla T + \alpha_1 [\nabla \times \mathbf{TH}], \quad (2)$$

where \mathbf{E} and \mathbf{H} are the electric and magnetic fields of the wave (there is no external magnetic field), \mathbf{j} is the current density, c is the velocity of light, ρ is the resistivity, α_0 is the thermo-emf, α_1 is the Nernst-Ettingshausen coefficient (NEC), and ∇T is the temperature gradient. The resulting dispersion equation is

$$\omega = -\alpha_1 c (\mathbf{k} \cdot \nabla T) - i \rho c^2 \mathbf{k}^2 / 4\pi, \quad (3)$$

in which ω is the circular frequency and \mathbf{k} is the wave vector.

The principal differences between the thermomagnetic waves (TMW) and previously known electromagnetic waves in metals are as follows:

1. The TMW can propagate in the absence of an external magnetic field; and
2. The waves propagate in a fixed direction: if $\alpha_1 > 0$, the waves propagate well when $\mathbf{k} \cdot \nabla T < 0$, i.e., they propagate against the temperature gradient. The wave propagating in the direction of ∇T damps out in a distance that is smaller than the skin depth.

TMW have been recently detected experimentally in a perfect bismuth specimen at helium temperatures.² A more detailed study of their propagation is therefore of interest.

The purpose of the work reported here was to improve the technique for observing TMW, to investigate the dispersion law of these waves experimentally, and to

compare the experimental dispersion equation with the theoretical one.

The case of weak damping is of special interest in the first stage of the investigation since in this case the imaginary term in the dispersion equation is small, and to investigate the dispersion law one need only measure the phase of the detected signal. Methods based on standing-wave resonance cannot be used here because of the unidirectionality of the wave propagation, so we used traveling waves.

Exciting and detecting coils were mounted at different positions along the length of the specimen. The phase φ of the detected signal was measured (as a function of the wave frequency and the temperature gradient along the specimen), and the wave vector $k = \varphi/l$, where l is the distance between the coils, was measured. To compare quantitatively the observed dispersion law with the theory one must know the product $\alpha_1 c \nabla T$, which occurs in the dispersion equation (3) as the coefficient of k . For bismuth at helium temperatures, the NEC α_1 depends on the transport characteristics of the phonon and electron systems (because of phonon dragging) and therefore depends on the degree of perfection, size, and surface quality of the crystal³; we therefore could not use values of α_1 determined for other specimens⁴ than ours. To produce a longitudinal temperature gradient in the specimen without substantially overheating it with respect to the bath we placed the specimen directly in the liquid helium. This made it difficult to measure directly ∇T and the NEC.

However, it turned out to be possible to measure $\alpha_1 \nabla T$ directly during the experiment. To do this we measured the potential difference that appeared between lateral contacts mounted on the specimen when a known static magnetic field was applied perpendicular to the line of contacts and to the axis of the specimen along which the temperature gradient was produced. This made it possible quantitatively to compare the observed dispersion law with the calculated dispersion equation on the basis of the results of static measurements made on the same specimens.

1. SPECIMENS AND MEASURING TECHNIQUES

In the experiments we used three single-crystal bismuth specimens grown by the Czochralski method.¹⁾

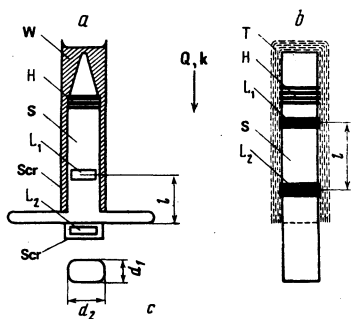

FIG. 1. Specimen shape and geometry of the experiment: a—BiO, b—Bi1 and Bi2, Scr—cross section of the specimens, S—specimen, H—heater, W—wax for thermal insulation, T—teflon for thermal insulation, Scr—lead, L_1 —exciting coil, L_2 —detecting coil. The values of d_1 , d_2 , and l are given in Table I. The arrow shows the direction of the heat flux Q and the wave vector k .

The shape of the specimens and the positions of the coils on them are shown in Fig. 1, and some characteristics of the specimens are listed in Table I.

The quantities d_1 , d_2 , and l are the transverse dimensions of the specimen and the distance between the coils (see Fig. 1), while $\rho_{293}/\rho_{4.2}$ is the ratio of the resistivities of the specimen measured at 293 and 4.2 °K. The crystallographic direction of the axis of the specimen is shown in the column of Table I headed "Orientation." The specimens were mounted vertically in the cryostat, directly in the liquid helium. A 10–20 ohm bifilar heater H served to produce the temperature gradient along the specimen; it was wound on a strip of tissue paper glued to the upper end of the specimen, sized with BF-2 adhesive, polymerized, and wrapped with several layers of cigaret paper, each layer being sized. The side surface of the specimen was thermally insulated to reduce heat loss from this part of the specimen.

The exciting coil was fed by an oscillator whose frequency could be smoothly varied between specified limits at a specified rate.

The signal from the detecting coil was brought through a 1 : 500 matching transformer to the input of a U2-6 amplifier operating in the broadband mode, the output of which was brought through a V9-2 synchronous detector to the Y input of an x-y plotter. Sometimes a two-way diode limiter was connected between the amplifier and the synchronous detector; then for strong signals the circuit operated as a phase detector with a linear phase characteristic, while for weak signals the limiter did not operate and the circuit worked as a synchronous detector with a cosinusoidal phase characteristic: $U = U_0 \cos \varphi$, where U_0 is the signal amplitude. By thus using the limiter one could record the phase of the

signal as a function of frequency even when the frequency variations led to large variations of the signal amplitude.

When recording frequency dependences, the X input of the x-y plotter was fed from the output of a capacitor frequency meter. In some cases we recorded the signal from the detecting coil as a function of the current through the heater that produces the temperature gradient.² Then one could operate the amplifier in the narrow band mode to improve the signal-to-noise ratio; in this case, however, not only does the temperature gradient vary, but the average temperature of the specimen also varies, and this leads to certain difficulties in interpreting the results.

The steady potential difference between the lateral contacts (which were soldered on with Wood's metal, using an air tool) is proportional to $\alpha_1 \nabla T$; it was measured with an R363 potentiometer and usually amounted to a few microvolts in a 0.71-Oe magnetic field. The field was produced by a set of Helmholtz coils. We did not use stronger fields because of the loss of the proportionality between the measured potential difference and the magnetic field strength, which is evidently associated with the field dependence of the NEC in fields stronger than 1 Oe. Using weaker fields increased the errors in measuring $\alpha_1 \nabla T$ to 5% and larger. The magnetic field was used only to measure $\alpha_1 \nabla T$. The earth's magnetic field was compensated to within 0.005 Oe during the measurements by a set of Helmholtz coils.

The main technical difficulties encountered during this work were those involved in producing a temperature gradient adequate for observing the TMW without substantially overheating the specimen as a whole, and in suppressing the direct coupling between the exciting and detecting coils. We approached the solution of these problems somewhat differently for the different specimens in order to be able to choose the most suitable technique for subsequent experiments.

For the BiO specimen the axis of the exciting coils, which were mounted on the side surface of the specimen, was horizontal. The detecting coil was mounted on the bottom face of the specimen with its axis parallel to that of the exciting coils. (Fig 1, a). To eliminate direct inductive coupling between the exciting and detecting coils, the side surface of the specimen with the coils was surrounded by a superconducting lead shield. The 0.2–0.5-mm gap between the specimen and the shield was filled with wax to reduce heat loss from the side surface. The lower part of the specimen was disk shaped and served as the cold finger. While drawing the specimen from the melt, the apparatus was suddenly stopped, and the metal remaining in the crucible proved to be fused to the single crystal that had been drawn up to that time. The resulting cold finger turned out to be fairly efficient, thanks to the lack of an interface between it and the specimen, its large area, and its high heat conductivity (due to the purity of the bismuth); it made it possible to produce a temperature gradient adequate for the first observations of TMW without significantly overheating the specimen with respect to the bath. However, the shape of the specimen

TABLE I.

Specimen	d_1 , cm	d_2 , cm	l , cm	Orientation	$\rho_{293}/\rho_{4.2}$
BiO	1.2	1.6	2.4	C_2	—
Bi1	1.3	1.7	4.4	C_2	630
Bi2	1.2	1.7	7.8	C_1	600

and the geometry of the experiment led to a number of disadvantages: it was difficult to grow the specimen owing to the danger of breaking the crucible; it was difficult to mount the specimen in the cryostat; the electromagnetic conditions near the coils were not homogeneous because of the presence of the superconducting shield; and it was impossible to work in a magnetic field, so that the Nernst-Ettingshausen emf could not be measured for this specimen.

The geometry was altered in subsequent experiments: specimens Bi1 and Bi2 had the nearly cylindrical shape (Fig. 1, b) standard for crystals grown by the method employed, and the coils were wound on the specimen over an insulating teflon film $15 \mu\text{m}$ thick. The side surface of the specimen was tightly wrapped with several layers of the same teflon strip, the lower part of the specimen ($\sim 4 \text{ cm}$ long) being left bare to serve as the cold finger.

The small gap between the coils and the specimen made it possible almost entirely to eliminate direct inductive coupling. Each of the coils was wound with several dozen turns of PEL-0.06 wire.

2. RESULTS

The conditions for observing TMW were found to improve with decreasing temperature. At temperatures below 1.6 K , however, turning on the heater resulted in a large drift of the helium-bath temperature, so we worked at temperatures from 1.6 to 2.2 K .

Figures 2 and 3 show recordings of the signal from the phase detector as a function of frequency for various values of the power dissipated in the heater that produces the temperature gradient. The numbers at the curves give the value in microvolts of the dc potential difference that develops between the lateral contacts when a steady magnetic field of 0.71 Oe is applied. These numbers are proportional to $\alpha_1 \nabla T$, and at a fixed temperature they are proportional to the temperature gradient. Control measurements showed that these potential differences are proportional to the square of the current through the heater, i.e., to the power dissipated in it.

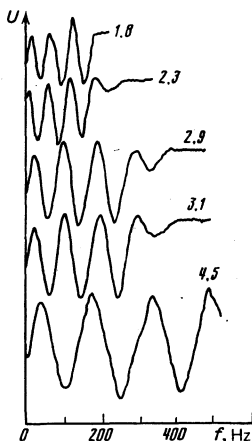

FIG. 2. Frequency dependence of the signal from the phase detector for various temperature gradients indicated at the curves in relative units. Specimen Bi1, $T = 1.75 \text{ K}$.

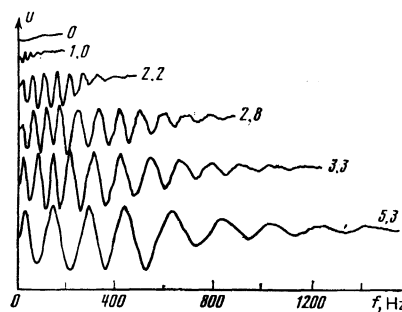

FIG. 3. Frequency dependence of the signal from the phase detector for various temperature gradients indicated at the curves in relative units. Specimen Bi2, $T = 1.7 \text{ K}$.

It is seen that as $\alpha_1 \nabla T$ increases, the amplitude and period of the oscillations, as well as the total number of oscillations observed, also increase. These oscillations are associated with the monotonic change in the phase of the TMW at the position of the detecting coil in the specimen, a single period of the oscillations corresponding to a shift of 2π in the phase of the detected wave. We made use of this circumstance to construct the frequency dependences of the real part of the x wave vector shown in Figs. 4, 5, and 6. The results of the calculated ω dependence of k are also shown for specimens Bi1 and Bi2.

In the above calculations we used the approximation of plane waves propagating without damping in an infinite medium. According to (3), in this case the dispersion equation is

$$k = -\omega / \alpha_1 c \nabla T. \quad (4)$$

To calculate $\alpha_1 \nabla T$ we used the definition of the NEC:

$$E_y = \alpha_1 H_x \nabla_z T,$$

in which E_y is the transverse component of the electric field as determined from the measured potential difference between the lateral contacts and the known width of the specimen, and $H_x = 0.71 \text{ Oe}$ is the applied magnetic field.

Figure 7 shows the frequency dependences of the wave vector at three helium-bath temperatures, all for the same value of $\alpha_1 \nabla T$. It will be seen that the measured

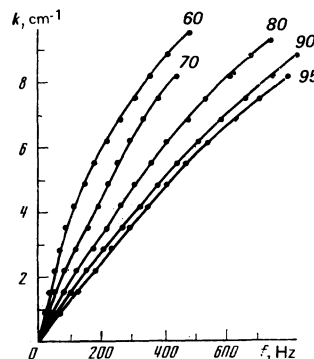

FIG. 4. Frequency dependence of the wave vector k for various heater powers. The numbers at the curves give the heater current in relative units. Specimen Bi0, $T = 2.0 \text{ K}$.

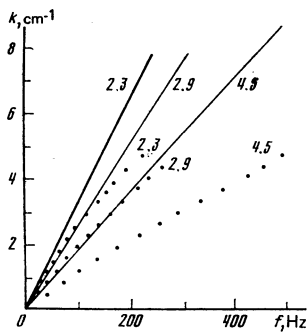

FIG. 5. Frequency dependence of the wave vector k for various values of $\alpha_1 \nabla T$ given in relative units by the numbers at the curves. The lines were calculated from the theory. Specimen Bi1, $T = 1.75$ °K.

curves are the same, within the measurement errors, for all three temperatures.

Figure 8 shows the dependence of the wave vector on the reciprocal heater power at a fixed frequency. This dependence is evidently quite accurately linear.

In Fig. 9 we have plotted the wave vector k vs its theoretical value k_T . It will be seen that k is almost directly proportional to k_T , and that the curves, which correspond to different specimens and different frequencies, are close to one another, although the experimental points lie below the theoretical line.

3. DISCUSSION

According to the dispersion equation (3), the wavelength of a TMW depends on the frequency of the wave, the temperature gradient in the medium in which the wave propagates, and the NEC of the medium. In our experiments we could vary all three of these parameters: we varied the first two directly by varying the frequency of the oscillator or the current through the heater, and we could vary the NEC indirectly by varying the temperature of the helium bath, since the NEC of bismuth is strongly temperature dependent⁴ in the temperature range employed in the experiments.

It is evident from Figs. 4–6 that the frequency dependence of the real part of the wave vector at fixed $\alpha_1 \nabla T$ is nearly linear: $k \propto \omega$.

Figures 8 and 9 show that the dependences of k on $1/P$ and k_T at fixed frequency are also nearly linear (in the experiment we actually varied the temperature gradient

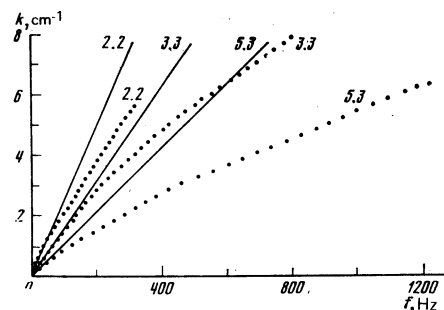

FIG. 6. Frequency dependence of the wave vector k . Specimen Bi2, $T = 1.7$ °K. The notation is the same as for Fig. 5.

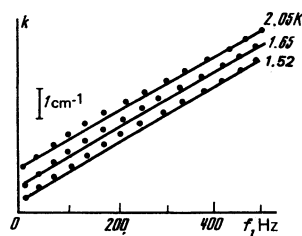

FIG. 7. Frequency dependences of the wave vector k for the various helium-bath temperatures indicated by the numbers at the curves. The curves have been shifted vertically with respect to one another for convenience in reading.

along the specimen): $k \propto 1/\nabla T$. Finally, it is evident from Fig. 7 that simultaneously changing the temperature of the helium bath (which alters α_1) and ∇T in such a manner that $\alpha_1 \nabla T$ remains constant does not alter the dispersion law. From this, together with the preceding condition ($k \propto 1/\nabla T$), we obtain $k \propto 1/\alpha_1 \nabla T$. Thus, the experimental dispersion law can be written as $k \propto \omega/\alpha_1 \nabla T$.

On comparing the experimental and theoretical values of the wave vector, we find that the theoretical values are somewhat the larger (Figs. 5, 6, and 9). In our opinion the main reason for the discrepancy between theory and experiment may be found in the fact that the theory was developed for the case of uniform plane waves propagating in an infinite medium without damping in the local limit, whereas these conditions did not obtain in the experiments.

The wavelengths of the waves excited in our experiments lay in the interval 0.8–12 cm, while a characteristic transverse dimension of the specimens was 1.5 cm. It is clear from this that waveguide effects must have been substantial in the long-wave part of the spectrum. The waveguide mode excited and detected in our experiments was close to the axially symmetric TE mode of a circular waveguide (see, e.g., Ref. 5). Hence the currents and fields in the wave were not uniform on the cross section of the specimen and had different directions with respect to the crystallographic axes of the specimen at different points. This nonuniformity will obviously depend on the wavelength, i.e., on the frequency and the temperature gradient in the specimen. Under these conditions the anisotropy of the kinetic properties of bismuth and the nonuniformity of the kinetic coefficients on the cross section (which makes itself felt at distances from the faces of the specimen

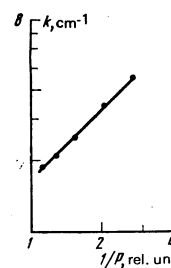

FIG. 8. Wave vector k vs the reciprocal heater power $1/P$ at 200 Hz. Specimen Bi0, $T = 2.0$ °K.

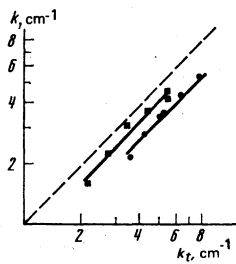

FIG. 9. Observed wave vector k vs the theoretical wave vector k_T as the longitudinal temperature gradient in the specimen is varied: ■—Bi1, $f=200$ Hz, $T=1.75$ °K; ●—Bi2, $f=200$ Hz, $T=1.7$ °K. The dashed line marks the theoretical relation $k = k_T$.

of the order of the carrier and phonon mean free path) can lead to considerable complication of the TMW dispersion law.

The electron mean free path in our specimens was of the order of 3 mm at $T \approx 2$ °K, and this is not much shorter than the length of the shortest waves excited in the experiments. It is evident from this that there could be substantial nonlocal effects in the short-wave part of the spectrum. The deviation of the frequency dependence of the real part of the wave vector from direct proportionality at high frequencies could be a consequence of the damping of the waves due to the finite resistivity of the medium.

Thus, there are a number of circumstances that, in our opinion, could account for the observed discrepancy between theory and experiment. Taking all this into account, we feel, that, on the whole, the current theory gives a quite satisfactory description of the observed TMW dispersion law.

CONCLUSION

Studies of the propagation of TMW and measurements of the static characteristics of the medium carried through on the same specimens in a single experiment has made it possible to compare the experimentally observed dispersion law for TMW with the theoretical

dispersion equation.

The results of the present experiments are in satisfactory agreement with the current theory; this provides reliable confirmation of the propagation of electromagnetic waves of a new type in a nonisothermal conductive medium in the absence of an external magnetic field at distances considerably exceeding the skin depth as a result of the interaction of the drift motion of the carriers with the alternating magnetic field of the wave.

A new method of measuring the thermomagnetic NEC may be based on the use of thermomagnetic waves. In some cases the new method may prove to be more suitable than the usual classical method, since the new method 1) does not require the application of a static magnetic field, 2) does not require contacts on the specimen, and 3) makes it possible to use radio frequency techniques, and this, in turn, makes it possible to increase the sensitivity, accuracy, and rapidity of the measurements.

The author is deeply grateful to E. P. Vol'skii for valuable discussions.

¹⁾The author is deeply grateful to I. N. Zhilyaev, who grew the specimens at the Institute of Solid State Physics, Academy of Sciences of the USSR.

¹L. É. Gurevich and B. L. Gel'mont, *Zh. Eksp. Teor. Fiz.* **46**, 884 (1964); **51**, 183 (1966) [*Sov. Phys. JETP* **19**, 604 (1964); **24**, 124 (1967)].

²V. N. Kopylov, *Pis'ma v Zh. Eksp. Teor. Fiz.* **28**, 131 (1978) [*JETP Lett.* **28**, 121 (1978)].

³V. N. Kopylov and L. P. Mezhov-Deglin, *Zh. Eksp. Teor. Fiz.* **65**, 720 (1973) [*Sov. Phys. JETP* **38**, 357 (1974)].

⁴I. Ya. Korenblit, M. E. Kuznetsov, and S. S. Shalyt, *Zh. Eksp. Teor. Fiz.* **56**, 8 (1969) [*Sov. Phys. JETP* **29**, 4 (1969)].

⁵L. D. Gol'dshtein and N. V. Zernov, *Élektromagnitnye polya i volny* (Electromagnetic fields and waves), Sovetskoe radio, Moscow, 1971.

Translated by E. Brunner