

# Allowance for double scattering of light in the determination of the critical exponents

L. V. Adzhemyan, L. Ts. Adzhemyan, L. A. Zubkov, and V. P. Romanov

Leningrad State University

(Submitted 23 June 1979)

Zh. Eksp. Teor. Fiz. 78, 1051-1061 (March 1980)

We calculate the angular and temperature dependences of the intensities of doubly scattered light, with extinction taken into account. Comprehensive measurements were made of the system  $\beta$ ,  $\beta'$ -dichlorethyl ether-iso-octane system in the vicinity of the critical stratification point, including a study of the scattering indicatrix at various temperatures, an investigation of the depolarized component, and measurement of the height dependence of multiply scattered light and of the attenuation of the transmitted beam. The contribution of the double scattering of light to the measured total intensity of the polarized component  $I_z^+$  is eliminated by a theoretical recalculation. This leads to an increase of the correlation radius  $r_c = r_0 \tau^{-\nu}$  and of the critical exponent  $\nu$ , and to a considerable decrease of  $r_0$ . The relation  $I_z^+ \pm \tau^{-\nu}$  is used to determine the critical exponent  $\gamma$ . The results are  $\gamma = 0.625 \pm 0.007$ ,  $\nu = 1.21 \pm 0.04$ , and  $r_0 = 2.36 \pm 0.16 \text{ \AA}$ .

PACS numbers: 42.20. - y

Double scattering of light in the vicinity of the critical point is being intensively investigated of late. Some of the main features of this scattering have been established theoretically and verified experimentally, namely, the unusual independence of volume, the faster growth of the intensity (compared with single scattering) when the critical point is approached, and the appearance of a depolarized component in the scattered light.<sup>1-6</sup> It was also shown that a study of this phenomenon can yield the scattering constant.<sup>7</sup>

A number of important aspects, however, have remained uninvestigated. Foremost among them is the angular dependence of the doubly scattered light in a real experiment, and its contribution to the total scattering indicatrix. In this connection, it was not even clear qualitatively how neglect of the double scattering influences the values of the critical exponents.

In the present paper we calculated the angular and temperature dependence of the intensity of doubly scattered light in a real experimental geometry, with extinction taken into account. To determine the parameters of this scattering, a comprehensive set of measurements was performed, including besides the usual study of the scattering indicatrices at various temperatures, additional investigations of the depolarized component and of the height dependence of the multiple scattering, and measurement of the attenuation of the transmitted light. This has made it possible, by theoretical recalculation, to eliminate the contribution of the double scattering to the experimentally measured total intensity, and to investigate the influence of this scattering on the critical exponents.

We recall first some information concerning the single scattering of light. Its intensity, as is well known, takes in the vicinity of the critical point the form<sup>8</sup>

$$I_{z(\perp)}^+ = \frac{I_0}{X^2} R_{\text{scat}} \exp[-\sigma(L_1 + L_2)] VG(q). \quad (1)$$

Here  $V$  is the observed part of the illuminated object,  $X$  is the distance from the scattering volume to the ob-

servation point, and  $I_0$  is the intensity of the incident light regarded as a plane monochromatic wave propagating along the  $x$  axis. The scattered light  $I_{\beta(\alpha)}^\alpha$  is investigated in the  $xy$  plane,  $\alpha$  and  $\beta$  are the polarizations of the incident and scattered light,  $\sigma$  is the extinction coefficient;  $L_1$  is the path traversed by the incident light in the medium prior to the scattering act, and  $L_2$  is the path of the scattered light in the medium;

$$G(q) = \langle |\delta c_q|^2 \rangle / \langle |\delta c_{q=0}|^2 \rangle,$$

$\delta c_q$  is the Fourier component of the fluctuation of the order parameter,  $q$  is the wave vector of the scattering,  $q = 2k \sin(\theta/2)$ ,  $k$  is the wave vector of the incident radiation in the medium, and  $\theta$  is the scattering angle.

In the Ornstein-Zernike approximation we have

$$G(q) = [1 + (qr_c)^2]^{-1},$$

where  $r_c$  is the correlation radius. We are interested in the vicinity of the critical stratification point, where  $\delta c_q$  is the fluctuation of the concentration. In this case the scattering constant is

$$R_{\text{scat}} = \frac{\pi^2}{\lambda^4} \left( \frac{\partial \epsilon}{\partial c} \right)_{P,T}^2 \frac{k_B T}{\rho} \left( \frac{\partial c}{\partial \mu} \right)_{P,T},$$

where  $\lambda$  is the wavelength of the light in vacuum,  $\epsilon$  is the dielectric constant,  $\mu$  is the chemical potential of the mixture,  $\rho$  is the mass density,  $k_B$  is the Boltzmann constant,  $T$  is the actual temperature, and  $P$  is the pressure. According to similarity theory

$$\left( \frac{\partial c}{\partial \mu} \right)_{P,T} \propto r_c^{2-\eta}, \quad r_c = r_0 \tau^{-\nu},$$

where  $\tau = |T - T_c|/T_c$ ,  $2 - \eta = \gamma/\nu$ .

It follows from (1) that a study of the angular and temperature dependences of the intensity of the singly scattered light yields the values of two critical exponents,  $\gamma$  and  $\nu$  or  $\nu$  and  $\eta$ , after which all the remaining exponents are calculated from the similarity-theory relations. In addition, it is possible to obtain the parameter  $r_0$  from the temperature dependence of  $r_c$ .

# 1. CALCULATION OF THE INTENSITY OF DOUBLY SCATTERED LIGHT

The contribution of the doubly scattered light to the total scattering intensity can be written in the form

$$I_{\beta(z)}^{\alpha} = \frac{I_0}{X^2} R_{\text{scat}}^3 \exp[-\sigma(L_1+L_2)] J_{\beta(z)}^{\alpha}, \quad (2)$$

$$J_{z(z)}^z = \int_{V_1} dR_1 \int_{V_2} dR_2 \frac{e^{-\sigma l_0}}{R^2} (1-m_z^2)^2 G(q_1) G(q_2), \quad (3)$$

$$J_{xy(z)}^z = \int_{V_1} dR_1 \int_{V_2} dR_2 \frac{e^{-\sigma l_0}}{R^2} m_z^2 [1-m_z^2 - (mn)^2] G(q_1) G(q_2), \quad (4)$$

where  $V_1$  is the volume illuminated by the incident light and  $V_2$  is the volume from which the scattered light enters the recording unit<sup>1</sup>; we assume  $V_1$  and  $V_2$  to be cylinders with equal lengths  $2L$  and with radii  $r_1$  and  $r_2$ ;  $\mathbf{R} = \mathbf{R}_2 - \mathbf{R}_1$ ,  $\mathbf{m} = \mathbf{R}/R$ ,  $\mathbf{q}_1 = k\mathbf{m} - \mathbf{k}$  is the wave vector of the primary scattering,  $\mathbf{q}_2 = k(\mathbf{n} - \mathbf{m})$  is the wave vector of the secondary scattering,  $\mathbf{n} = \mathbf{X}/X$  is the direction to the observation point, and  $l_0$  is the difference between the paths of the doubly and singly scattered light (see Fig. 1).

In the calculation of the integrals (3) and (4) we neglect the attenuation of the rays over the distances  $r_1$  and  $r_2$ , i.e., we put  $\sigma r_1 = \sigma r_2 = 0$ . We consider two cases,  $h \gg r_{1,2}$  and  $h = 0$ . In the first case, the integration over the cross sections of the cylinders is trivial, and we have

$$I_{z(z)}^z(h) = A \frac{1}{[1+2(kr_c)^2]^2} \int_{-L/h}^{L/h} dl_1 \int_{-l_1/h}^{l_1/h} dl_2 \frac{l^4}{(l^2+1)^3} \times \exp[\sigma h(l_2 - l_1 - (l^2+1)^{1/2})] \left(1 - \alpha \frac{l_2 \cos \theta - l_1}{(l^2+1)^{1/2}}\right)^{-1} \left(1 - \alpha \frac{l_2 - l_1 \cos \theta}{(l^2+1)^{1/2}}\right)^{-1}, \quad (5)$$

$$I_{xy(z)}^z(h) = A \frac{\sin^2 \theta}{[1+2(kr_c)^2]^2} \int_{-L/h}^{L/h} dl_1 \int_{-l_1/h}^{l_1/h} dl_2 \frac{l_1^2}{(l^2+1)^3} \times \exp[\sigma h(l_2 - l_1 - (l^2+1)^{1/2})] \left(1 - \alpha \frac{l_2 \cos \theta - l_1}{(l^2+1)^{1/2}}\right)^{-1} \left(1 - \alpha \frac{l_2 - l_1 \cos \theta}{(l^2+1)^{1/2}}\right)^{-1}, \quad (6)$$

where

$$\alpha = \frac{2(kr_c)^2}{1+2(kr_c)^2}, \quad l^2 = l_1^2 + l_2^2 - 2l_1 l_2 \cos \theta,$$

$$A = \frac{I_0}{X^2} R_{\text{scat}}^3 e^{-2\sigma L} \pi^2 r_1^2 r_2^2.$$

In the case  $h = 0$  we use the smallness of the parameter  $r_{1,2}/L$  and assume the extinction coefficient  $\sigma$  to be not too large. Then, accurate to terms that do not vanish as

$$\left(\frac{r_{1,2}}{L}\right)^2 \exp\left[2\sigma L\left(1 - \cos \frac{\theta}{2}\right)\right] \rightarrow 0$$

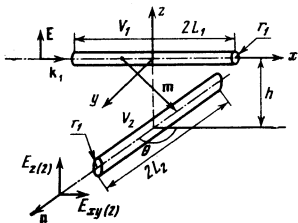

FIG. 1. Experimental geometry for the investigation of double scattering of light.

we obtain<sup>2</sup>

$$I_{z(z)}^z(h=0) = A \frac{2}{[1+2(kr_c)^2]^2} \left\{ \frac{2\pi(1-\cos \theta)}{\alpha^4 \sin^4 \theta} \left[ \frac{1-(1-\alpha^2)^{1/2}}{\cos^2(\theta/2)} - \frac{\alpha^4}{(1-\alpha^2)^{1/2} [1-\alpha^2 \cos^2(\theta/2)]} \ln \frac{1+(1-\alpha^2)^{1/2}}{2(1-\alpha^2)^{1/2}} \right] - \frac{\pi - \theta - 2 \arctg[(1-\alpha^2)^{1/2} \text{ctg}(\theta/2)]}{\cos^2(\theta/2) \sin \theta [1-\alpha^2 \cos^2(\theta/2)]} \right\} + \int_{-L/r_2}^{L/r_2} dl_1 \int_{-l_1/r_1}^{l_1/r_1} dl_2 \exp[\sigma r_2(l_2 - l_1 - l)] \frac{(1+l^2)^{1/2} - l}{l} \times \left(1 - \alpha \frac{l_2 \cos \theta - l_1}{l}\right)^{-1} \left(1 - \alpha \frac{l_2 - l_1 \cos \theta}{l}\right)^{-1}, \quad (7)$$

$$I_{xy(z)}^z(h=0) = A \frac{\pi}{\alpha^4 \sin^4 \theta [1+2(kr_c)^2]^2} \left\{ 2(1+\cos \theta) [1-(1-\alpha^2)^{1/2}] - \alpha^2 \cos \theta - \frac{2[1-(1-\alpha^2)^{1/2}]}{\cos^2(\theta/2)} + \frac{\text{tg}(\theta/2)}{\cos^2(\theta/2)} \left[ \pi - \theta - 2 \arctg \left( (1-\alpha^2)^{1/2} \text{ctg} \frac{\theta}{2} \right) \right] \right\}. \quad (8)$$

In the case of small extinction, when

$$2\sigma L(1-\cos(\theta/2)) \ll 1, \quad (9)$$

Eq. (7) can be further simplified:

$$I_{z(z)}^z(h=0) = A \frac{2\pi}{\sin^4 \theta [1+2(kr_c)^2]^2} \times \left\{ \frac{1}{1-\alpha^2 \cos^2(\theta/2)} \frac{1}{(1-\alpha^2)^{1/2}} \left[ \ln \frac{4L(1-\alpha^2)^{1/2} \sin \theta}{r_2 [1+(1-\alpha^2)^{1/2}]} + \frac{1}{2} \right] + \frac{1-(1-\alpha^2)^{1/2}}{\alpha^4 \cos^2(\theta/2)} - \frac{\pi - \theta - 2 \arctg[(1-\alpha^2)^{1/2} \text{ctg}(\theta/2)]}{\alpha^4 \cos^2(\theta/2) \sin \theta [1-\alpha^2 \cos^2(\theta/2)]} - \frac{2}{\pi} \int_{\theta/2-\pi/2}^{\theta/2} d\varphi \frac{1+\alpha^2 \cos \varphi \cos(\varphi-\theta)}{(1-\alpha^2 \cos^2 \theta) [1-\alpha^2 \cos^2(\varphi-\theta)]} \ln[\sin(\theta-\varphi)] \right\}. \quad (10)$$

In the derivation of this formula it was assumed that  $r_2 > r_1$ . In the opposite case it is necessary to replace  $r_2$  by  $r_1$  in the logarithmic term outside the integral. We note that actually the condition (9) is too stringent. Numerical calculations show that Eq. (10) remains valid within about 10% up to  $2\sigma L \sim 1$  (see Fig. 9 below).

The use of relations (8) and (10) at  $kr_c \ll 1$  calls for certain accuracy. Resolving the indeterminacy, we have at  $kr_c = 0$

$$I_{z(z)}^z(h=0, kr_c=0) = A \frac{2\pi}{\sin^4 \theta} \left\{ \ln \frac{2L \sin \theta}{r_2} + \frac{1}{4} - \frac{2}{\pi} \int_{\theta/2-\pi/2}^{\theta/2} d\varphi \ln[\sin(\theta-\varphi)] \right\},$$

$$I_{xy(z)}^z(h=0, kr_c=0) = A \frac{\pi}{4 \sin^4 \theta}. \quad (11)$$

## 2. EXPERIMENTAL PROCEDURE AND REDUCTION OF THE MEASUREMENT RESULTS

The measurements were performed with the setup illustrated in Fig. 2. The laser beam passed through a polarizer and a prism system that made it possible to vary the height of the beam and enter a cylindrical quartz cell of diameter  $2L = 60$  mm. The scattered light passed through a narrow slit cut in the bulky copper housing, which was thermostatically controlled with accuracy  $3 \times 10^{-3}$  deg and was mounted on a goniometer. The laser beam passed through the center of the goniometer, which coincided with the axis of the cell accurate to 0.3 mm, and a photomultiplier was aimed with the same accuracy on the same axis of the cell. The measurements were made in the scattering-angle range

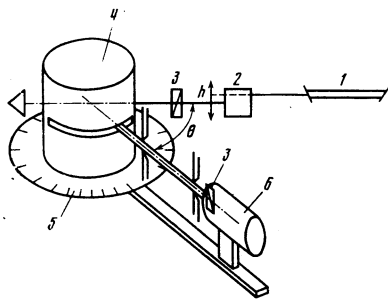

FIG. 2. Diagram of experimental setup: 1—He-Ne laser; 2—device to raise and lower the beam; 3—polarizers; 4—bulky heat-insulated copper jacket inside which is placed the cell with the scattering liquid; 5—goniometer; 6—photomultiplier.

from 15° to 140°. The angle measurement accuracy was 2'.

We investigated the scattering of light in a solution of  $\beta$ ,  $\beta'$ -dichloroethyl ether—iso-octane ( $T_c = 26.6^\circ\text{C}$ ;  $c = 44$  deg. %  $\text{C}_8\text{H}_{18}$ ), which was pressed after purification into the cell through a microporous filter with pore diameter 0.5  $\mu\text{m}$ .

The collimating unit was so constructed that the volume  $V_2$  (Fig. 1) was, with sufficient degree of accuracy, a cylinder of effective radius  $r_2 = 1.5$  mm. The radius of the laser beam in the cell was  $r_1 = 0.15$  mm.

We measured the intensities of the components of the scattered light  $I_z^z$  and  $I_{xy}^z$  at  $h = 0, 4, 6,$  and  $8$  mm and in the relative-temperature range  $\tau \sim 2 \times 10^{-3}$ , in angle steps of 5°. The measurements were made with a cooled photomultiplier in the photon-counting regime, with accuracy of the order of 2%.

To exclude the double scattering  $I_{z(2)}^z$  from the total intensity we can use one of two relations

$$I_{z(2)}^z = \frac{J_{z(2)}^z}{J_{xy(2)}^z} I_{xy \text{ exp}}^z, \quad (13)$$

$$I_{z(2)}^z = \frac{J_{z(2)}^z}{J_{z(2)}^z(h)} I_{z^z(h) \text{ exp}}, \quad (14)$$

which follow from Eq. (2). In the first of these equations we use the experimental values of the depolarized component  $I_{xy \text{ exp}}^z$ , while in the second we use the components  $I_{z^z(h) \text{ exp}}$  at  $h \neq 0$ . As seen from (7) and (8), to perform the required recalculation it is necessary to know, besides the geometry of the setup, also the extinction coefficient. To calculate the latter we use the relation

$$\sigma = \frac{\pi}{2} B \left[ (1 + \alpha^{-2}) \ln \frac{1 + \alpha}{1 - \alpha} - \frac{2}{\alpha} \right], \quad (15)$$

$$B = R_{\text{scat}} / (kr_c)^2,$$

which was obtained in the lowest-order approximation in the fluctuations of the order parameter using the Ornstein-Zernike formula.<sup>9</sup>

The correlation radius at different values of the temperature was determined in the zeroth approximation from the angular dependence of the component  $I_z^z$  under the assumption that it is described by formula (1) (see, e.g., curve 1 on Fig. 7 below).

The scattering constant was determined from the relation

$$R_{\text{scat}} = \frac{I_{xy \text{ exp}}^z}{I_{z \text{ exp}}^z} \frac{VG(q)}{J_{xy(2)}^z} \quad (16)$$

which follows from (1) and (2). It is important here that the quantities  $G(q)$  and  $J_{xy(2)}^z$  do not depend on the extinction coefficient. A statistical reduction of the data for various temperatures yielded

$$B = R_{\text{scat}} / (kr_c)^2 = 0.050 \pm 0.005 \text{ cm}^{-1}.$$

In the calculations with formula (16) we used for  $I_{xy \text{ exp}}^z$  the values extrapolated from the height dependence of the curve  $I_{xy}^z(h)$  to  $h = 0$  (see Fig. 3). We have thereby excluded both the influence of the parasitic extraneous illumination due to partial transmission of the polarized component  $I_z^z$ , which is very large at  $h = 0$ , and the influence of the possible depolarization in single scattering. The maximum jump

$$[I_{xy}^z - I_{xy}^z(h \rightarrow 0)] / I_{xy}^z$$

was 15%. We note that a similar extrapolation of the experimental data on the height variation of the component  $I_z^z(h)$  to  $h = 0$ , which would be the simplest method of determining  $I_{z(2)}^z$ , is impossible because of the strong  $I_z^z(h)$  dependence at small  $h$  (see Fig. 3).

To monitor the results we measured first the relative attenuation of the intensity of the transmitted light as a function of temperature. Within the limits of experimental error, this attenuation is described by Eq. (15) with the previously obtained value of  $B$ . Second, we compared the theoretical and experimental double-scattering indicatrices (see Fig. 4), as well as the dependences of the intensities  $I_z^z$  and  $I_{xy}^z$  on the height  $h$  at an angle 90° (see Fig. 3).

The value of  $I_{z(2)}^z$  was determined by two methods [from (13) and (14)]. We calculated for this purpose the "conversion coefficients"  $J_{z(2)}^z / J_{xy(2)}^z$  and  $J_{z(2)}^z / J_{z(2)}^z(h)$  with the obtained value of  $\sigma(r_c)$ . The first of these coefficients is shown in Fig. 5 as a function of the scattering angle and of the correlation radius. It is seen from the figure that the ratio  $J_{z(2)}^z / J_{xy(2)}^z$  differs noticeably from unity and depends substantially on  $kr_c$  and on the scattering angle. This shows that the previously held opinion, that the intensities  $I_{z(2)}^z$  and  $I_{xy(2)}^z$  are of the same order, is in error. The second coefficient  $J_{z(2)}^z / J_{z(2)}^z(h)$  depends little on  $kr_c$  and on the scattering

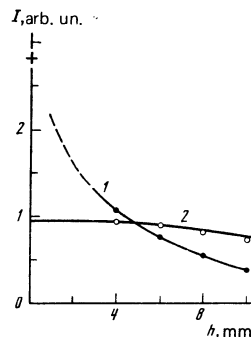

FIG. 3. Height dependence of the components of the scattered light  $kr_c = 0.835$ . Solid lines—calculated values: 1— $0.1I_{z(2)}^z(h)$ , 2— $I_{xy(2)}^z(h)$ ; points—experimental. The cross on the ordinate axis indicates the theoretical value of the component  $I_{z(2)}^z$  at  $h = 0$ .

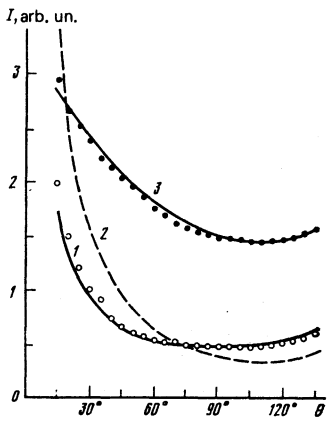

FIG. 4. Double scattering indicatrices,  $k\gamma_c = 0.835$ . Solid lines—calculated values: 1— $I_{xy(2)}^z(h=0)$ , 2— $\sim 0.002I_{z(1)}^z$ , 3— $0.25I^z(h=6)$ . Points—experiment. The dashed curve shows for comparison the single-scattering indicatrix.

angle in the considered range of angles and heights  $h$ . Its numerical value can be assessed from Fig. 3.

In view of the large value of the ratio  $J_{xy(2)}^z/J_{xy(2)}^z$ , the fraction of the double scattering in our system turned out to be quite appreciable, although the depolarization coefficient was relatively small ( $\sim 10^{-2} - 10^{-3}$ ). This is illustrated in Fig. 6, which shows the dependence of the ratio  $I_{z(2)}^z/I_z^z$  on  $k\gamma_c$ . As seen from the figure, this value reached 15%.

After eliminating  $I_{z(2)}^z$  from the total intensity, we obtained the corrected correlation radius. The difference between the indicatrices  $I_z^z$  and  $I_{z(1)}^z = I_z^z - I_{z(2)}^z$  is illustrated in Fig. 7. It is seen from the figure that both methods of excluding the double scattering yielded practically the same results. The correction to  $r_c$  reached in our case 10%. From the corrected values of  $r_c$  we obtained  $r_0 = 2.36 \pm 0.16 \text{ \AA}$ ,  $\nu = 0.625 \pm 0.007$ ; the corresponding uncorrected values were  $r_0 = 3.20 \text{ \AA}$ ,  $\nu = 0.58$ .

The main error in the values of  $r_0$  and  $\nu$  is due to the accuracy in the determination of the temperature. A considerable uncertainty in the extinction coefficient ( $\sim 10\%$ ) had practically no effect on the accuracy of  $r_0$  and  $\nu$ , since the fraction of the double scattering depends little on  $\sigma$ . Even at  $\sigma = 0$  it differs from the real value by not more than 10%. This is due to the fact that, as seen from Fig. 8, which shows the dependence

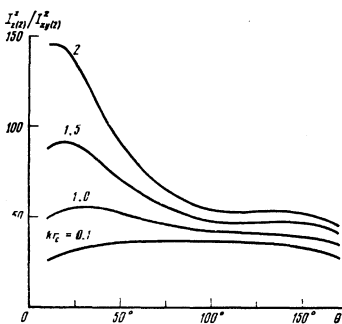

FIG. 5. Calculated component-intensity ratios  $I_{z(2)}^z/I_{xy(2)}^z$  as functions of the scattering angle.

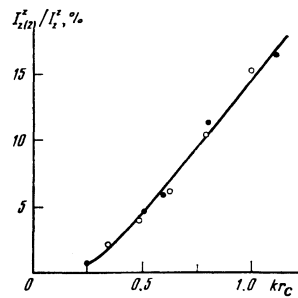

FIG. 6. Relative fraction of double scattering of light in the total intensity ( $\theta = 90^\circ$ ), calculated from the experimental values of  $I_{z(2)}^z(h)$  (●) and  $I_{xy(2)}^z$  (○). Solid line—calculation by formulas (1) and (7).

of the intensities of the double scattering on the cell dimensions, the main contribution to the double scattering is made by that region of the investigated system in which  $l_0 \ll \sigma^{-1}$ , where  $l_0$  is the difference between the paths of the doubly and singly scattered light. We note that from Fig. 8 it follows also that a decrease of the contribution of the double scattering to the total intensity, by decreasing the cell dimensions  $L$ , is not effective, since  $I_2 \sim \ln(L/r_2)$ . It is more effective to decrease the dimensions of the photoreceiver diaphragms, i.e.,  $r_2$ , inasmuch as  $I_{(2)}/I_{(1)} \sim r_2$ .

The next steps in the iteration procedure [substitution of the corrected value of  $r_0$  in Eq. (13), (14), and (16), and replacement of  $I_{z(2)}^z$  by  $I_{z(1)}^z$  in (16)] are hardly justified when only double scattering is taken into account.

The critical exponent  $\gamma$  was determined from the temperature dependence of the quantity

$$I_{z(1)}^z \sim e^{-2\sigma L} G \tau^{-\gamma}.$$

This relation is very sensitive to the value of the extinction coefficient, particularly at small  $\tau$  (in our experiment  $2\sigma L$  reached values of the order of unity). Therefore the principal error in the determination of  $\gamma$  from this relation is due to the error in the determination of  $\sigma$ . To decrease the error we used data on the attenuation of the light passing through the cell,  $I_{tr} \sim e^{-2\sigma L}$ , and obtained  $\gamma$  in fact from the relation

$$I_{z(1)}^z/I_{tr} G \sim \tau^{-\gamma},$$

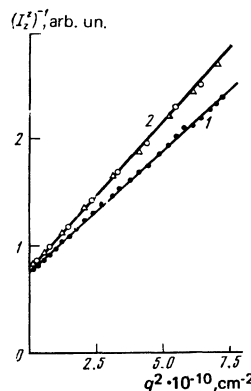

FIG. 7. Dependence of the reciprocal component intensity  $I_z^z$  on the scattering vector. Points on line 1—experimental values;  $\Delta$  and  $\circ$  on line 2 correspond to exclusion of the double scattering from  $I_z^z$  in accordance with the experimental values of  $I_z^z(h)$  and  $I_{xy}^z$ .

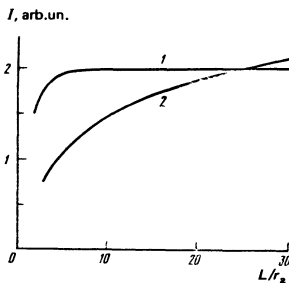

FIG. 8. Dependence of the components of the doubly scattered light on the cell dimensions: 1— $I_{xy}^z$ , 2— $I_z^z(2)$ .

in which there is no need to know  $\sigma$ . We obtained  $\gamma = 1.21 \pm 0.04$  (if no allowance is made for the double scattering in the intensity we get  $\gamma = 1.17$  for the uncorrected value of  $r_c$  and  $\gamma = 1.29$  for the corrected value of  $r_c$ ).

The critical exponents  $\nu$  and  $\gamma$  obtained by us for a relatively strongly opalescent medium agreed with the most accurate values obtained for weakly opalescent systems.<sup>10,11</sup> We note also that our estimate of the fraction of the double scattering under the conditions of Ref. 10 has shown that it does not exceed 2–3%, so that the double scattering apparently does not influence the values of the critical exponents obtained in that paper.

Another method of determining the critical exponent  $\gamma$  is to study the temperature dependence of the scattering constant  $R_{\text{scat}}$  with the aid of relation (16). This method yielded  $\gamma = 1.19$ . It is difficult to indicate here the error in  $\gamma$ , since we cannot estimate the contribution of the triple scattering to  $I_{xy}^z$ , although for weakly opalescent systems the accuracy may be quite high.

In cases of small depolarization that is not connected with multiple scattering, it is more advantageous to determine the exponent  $\gamma$  from the component  $I_{z(2)}^z(h)$ :

$$\tau^{-\gamma} \sim \frac{I_{z(2)}^z(h)_{\text{exp}} VG(q)}{I_{z \text{ exp}}^z J_{z(2)}^z(h)}. \quad (17)$$

We can use also the other components of the double scattering. A similar method is discussed by Beysens and Zalczer,<sup>5</sup> who, in contrast to our method, carried out the integration over a certain height interval. On the basis of experimental data it was proposed by them that the geometric factor, analogous to the quantity  $\Phi \equiv J_{z(2)}^z(h)/G(q)$  in (17), with extinction taken into account, does not depend on  $r_c$ , and one can use for estimates its value at  $r_c = 0$ . It follows from our calculations that in the general case this assumption does not hold true.

Figure 9 shows the dependence of the geometric factor on  $r_c$  at different values of  $B$  and at  $h = 6$  mm. As seen from the figure, for weakly opalescent systems ( $B \sim 0$ ) the quantity  $\Phi$  decreases with increasing  $kr_c$ . The reason for this behavior is that, according to (3), the quantity  $J_{z(2)}^z$  contains two factors  $G$ , which decrease with increasing  $r_c$  at  $kr_c > 1$ . On the contrary, for strong opalescence and sufficiently large  $kr_c$ , the value of  $\Phi$  increases, because in double scattering there exist rays that cover paths in single scattering, and are consequently much less attenuated. For definite  $B$  in a certain region of values of  $kr_c$ , partial cancellation of these two factors takes place, and this has apparently

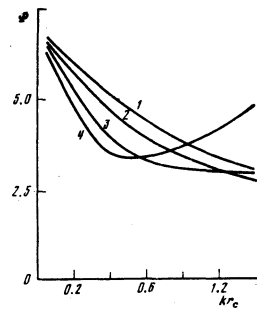

FIG. 9. Dependence of the geometric factor  $J_{z(2)}^z(h)/G$  on the correlation radius at different values of the coefficient  $B$ : 1— $B = 0$ , 2— $B = 0.05 \text{ cm}^{-1}$ , 3— $B = 0.2 \text{ cm}^{-1}$ , 4— $B = 0.4 \text{ cm}^{-1}$ .

occurred in Ref. 5. Calculations show that the character of the dependence of  $\Phi$  on  $kr_c$  does not change with changing  $h$  down to  $h = 0$ .

Our results lead to conclusions of general character concerning the influence of double scattering on the critical exponent  $\nu$  and on the value of  $r_0$ . Since the intensity of the double scattering at  $h = 0$  is a weaker function of angle than the intensity of single scattering (see Fig. 4), after subtracting this intensity the scattering indicatrix assumes a more elongated shape, and this leads to an increase of the correlation radius. This effect becomes stronger when the critical point is approached, since the fraction of the double scattering increases in this case (see Fig. 6). Thus, exclusion of the double scattering leads to an increase of the critical exponent  $\nu$ . Far from the critical point the double scattering leads to no corrections to the correlation radius. Therefore lowering the value of  $\nu$  in the calculation of  $r_c = r_0 \tau^{-\nu}$  leads to a sharp increase of  $r_0$  and consequently, when the double scattering is excluded, the value of  $r_0$  decreases. It can be proposed that the large values of  $r_0$  obtained in a number of studies (see, e.g., Refs. 12 and 13) and the underestimates of  $\nu$  are due to failure to take double scattering of light into account.

The influence of double scattering on the critical exponent  $\gamma$ , determined from the relation

$$\tau^{-\gamma} \sim I_z^z G^{-1}(q) \exp(2\sigma_{\text{exp}} L),$$

is due to competition between two factors: On the one hand the contribution of double scattering overestimates the rate of increase of  $I_z^z$ . On the other, as we have seen, it underestimates  $r_c$ , and with it also the factor  $G^{-1}(q)$ . Thus, the value of  $\gamma$  obtained in the region  $kr_c \ll 1$  is too high, but for the region  $kr_c \gg 1$  it is impossible to predict unambiguously the influence of the double scattering on the value of  $\gamma$ . In our system, the influence of the factor  $G$  turned out to be stronger, i.e., the value of  $\gamma$  with double scattering neglected was too low, and when the corrected value of  $r_c$  was substituted in  $G(q)$  we obtained, naturally, an overestimated value of  $\gamma$ .

In conclusion, the authors are sincerely grateful to I. L. Fabelinskii and M. A. Anisimov for a discussion of the work and valuable critical remarks, to V. A. Solov'ev for constant interest in the work and for helpful advice, and to R. K. Turniyazov for help with the experiment.

- <sup>1</sup>In Formula (1),  $V$  is the common part of the volumes  $V_1$  and  $V_2$ .
- <sup>2</sup>The quantity  $2L(1 - \cos(\theta/2))$  has the meaning of the maximum difference between the paths of the singly and doubly scattered light.
- <sup>3</sup>The coefficients  $I_\beta^\alpha$  at  $h \neq 0$  will be designated by  $I_\beta^\alpha(h)$ , and at  $h=0$  we shall omit the argument.
- <sup>4</sup>D. W. Oxtoby and W. M. Gelbart, *J. Chem. Phys.* **60**, 3359 (1974).
- <sup>5</sup>E. L. Lakoza and A. V. Chalyi, *Zh. Eksp. Teor. Fiz.* **67**, 1050 (1974) [*Sov. Phys. JETP* **40**, 521 (1974)].
- <sup>6</sup>L. V. Adzhemyan, L. Ts. Adzhemyan, L. A. Zubkov, and V. P. Romanov, *Pis'ma Zh. Eksp. Teor. Fiz.* **22**, 11 (1975) [*JETP Lett.* **22**, 5 (1975)].
- <sup>7</sup>L. A. Reith and H. L. Swinney, *Phys. Rev. A* **12**, 1094 (1975).
- <sup>8</sup>D. Beysens and G. Zalczar, *Opt. Commun.* **26**, 172 (1978).
- <sup>9</sup>A. J. Bray and R. F. Chang, *Phys. Rev. A* **12**, 2594 (1975).

- <sup>10</sup>L. A. Reith and H. L. Swinney, *Opt. Commun.* **17**, 111 (1976).
- <sup>11</sup>I. L. Fabelinskii, *Molekulyarnoe rasseyaniye sveta (Molecular Scattering of Light)*, Nauka, Moscow, 1965 [Plenum, (1968)].
- <sup>12</sup>V. G. Puglielli and N. C. Ford, Jr., *Phys. Rev. Lett.* **25**, 143 (1970).
- <sup>13</sup>M. A. Anisimov, A. M. Evtushenkov, Yu. F. Kiyachenko, and I. K. Yudin, *Pis'ma Zh. Eksp. Teor. Fiz.* **20**, 378 (1974) [*JETP Lett.* **20**, 176 (1974)].
- <sup>14</sup>M. A. Anisimov, A. T. Berestov, V. Ya. Voronov, Yu. F. Kiyachenko, B. A. Koval'chuk, V. M. Malyshev, and V. A. Smirnov, *Zh. Eksp. Teor. Fiz.* **76**, 1661 (1979) [*Sov. Phys. JETP* **49**, 844 (1979)].
- <sup>15</sup>M. Giglio and G. B. Benedek, *Phys. Rev. Lett.* **23**, 1145 (1969).
- <sup>16</sup>B. Chu, *Ber. Bunsenges. Phys. Chem.* **76**, 202 (1972).

Translated by J. G. Adashko

## Properties of the normal state and superconductivity in the Laves phases of $V_2Hf_{1-x}Zr_x$

V. A. Marchenko and V. M. Polovov

*Institute of Solid State Physics, USSR Academy of Sciences*

(Submitted 5 July 1979)

*Zh. Eksp. Teor. Fiz.* **78**, 1062-1075 (March 1980)

The superconductivity transition temperatures  $T_c$ , the temperature dependences of the magnetic susceptibility  $\chi$ , and the heat capacity  $C_p$  of  $V_2Hf_{1-x}Zr_x$  alloys ( $0 \leq x \leq 1$ ) are measured. In a narrow concentration range ( $0.3 \leq x \leq 0.4$ ) in which  $T_c$  attains its maximum and the structural transition temperature  $T_M$  is minimal, the transition entropy changes drastically from  $\sim 2$  J/mole-K (alloys closer to  $V_2Hf$ ) to 5.5 J/mole-K (alloys closer to  $V_2Zr$ ). This corresponds to a change in the nature of the structural instability. The highest values of  $\chi(T)$  are attained at temperatures that exceed  $T_M$  somewhat. They are the same for all values of  $x$  and are equal to  $3.8 \times 10^{-4}$  emu/g-atom. On the assumption that the orbital contribution is constant, it is concluded that the effective density of the electron states plays the decisive role in the onset of the structural transition. The low-temperature phase is characterized by a narrow ( $\sim 500$  K) minimum in the energy dependence of the state density. An analysis of the high-temperature entropy shows that lattice instability is accompanied by anharmonicity effects that manifest themselves in an appreciable decrease of the geometric mean phonon-spectrum frequency during cooling. It is suggested that the anharmonicity is due to electron contributions to the lattice dynamics.

PACS numbers: 74.70.Dg, 74.70.Lp, 71.20. + c

### INTRODUCTION

Alloys based on the compounds  $V_2Hf$  and  $V_2Zr$  with C-15 structure have superconducting transition temperatures  $T_c$  up to 10 K.<sup>1</sup> The high values of the critical field  $H_{c2}(4.2 \text{ K}) \approx 230 \text{ kOe}$ ,<sup>1</sup> the increased endurance under irradiation,<sup>2</sup> and the lower formation temperatures<sup>3</sup> make them attractive in technical applications.

These isostructural and isoelectronic ( $Z = 4.67$  electrons per atom) compounds undergo at temperatures close to 100 K first-order phase transitions from the high-temperature cubic modifications into an orthorhombic ( $V_2Hf$ , Ref. 4) or an rhombohedral ( $V_2Zr$ , Ref. 5) low-temperature phase. X-ray structure investigations<sup>6</sup> reveal the presence of small but reliably measurable jumps of the lattice parameters at the structural-transition temperature, but the temperature dependences of such quantities as the resistivity or the

specific magnetic susceptibility<sup>7</sup> do not exhibit the discontinuities typical of first-order transitions.

A correlation is observed between the superconducting and structural transitions  $T_c$  and  $T_m$  (the minimum of  $T_m$  corresponds to a maximum of  $T_c$ ). This correlation seems to attest to a close connection between the superconductivity of the  $V_2Hf_{1-x}Zr_x$  phases and the behavior of their lattice properties. From this point of view it is of interest to ascertain how the superconducting characteristics of the  $V_2Hf_{1-x}Zr_x$  compounds depend on the properties in the normal state [such as the electronic state density at the Fermi level  $N(E_F)$ , the characteristic phonon frequencies  $\tilde{\omega}_s$ , and others].

The properties of the compounds  $V_2Hf$  and  $V_2Zr$  are the subject of a large number of papers (see, e.g., the bibliography in Ref. 8), but alloys on their basis have so far not been extensively investigated.