

Magnetic-field-induced photovoltaic effect in *p*-type gallium arsenide

A. V. Andrianov, E. V. Beregulin, Yu. B. Lyanda-Geller, and I. D. Yaroshetskii

A. F. Ioffe Physicotechnical Institute, Russian Academy of Sciences
(Submitted 16 July 1992)

Zh. Eksp. Teor. Fiz. **102**, 1703–1716 (November 1992)

Experimental and theoretical investigations were made of the Hall and non-Hall linear photovoltaic effects in a magnetic field and of the magnetically induced circular photovoltaic effect in *p*-type GaAs. The physical nature of the observed effects was determined. Both a qualitative and quantitative agreement was achieved between the experiments and the theory of the effects induced by infrared CO₂ laser radiation. Depending on the hole density and on temperature, the effect could be attributed to the asymmetry of the scattering of holes by phonons or impurities, and also to the asymmetry of the interaction with the incident radiation. It was shown additionally that the characteristic features of the dynamics of particles with a spin in noncentrosymmetric crystals ensured that the magnetic-field-induced circular photovoltaic effect (absent when the field was $H = 0$) was an order of magnitude greater than the Hall and non-Hall currents associated with rotation of the distribution function for the linear photovoltaic effect when $H = 0$.

1. INTRODUCTION

The photovoltaic effects (PVEs) in noncentrosymmetric crystals have attracted much attention in the last decade. These effects are related neither to the dissociation of electron-hole pairs due to an inhomogeneity of a crystal or due to illumination, as is true of the Dember effect or of the barrier photoelectric effect, nor to the transfer of the momentum of electromagnetic waves of electrons, which occurs when electrons are dragged by photons. The physical cause of the PVEs in noncentrosymmetric crystals is the asymmetry and anisotropy of the photoexcitation, light scattering, and carrier recombination.

It is usual to distinguish the circular PVE, which appears in gyrotropic crystals when they are illuminated with circularly polarized light, and the linear PVE, which occurs in piezoelectrics when they are excited with linearly polarized (and, in some cases, unpolarized) light.

The investigations reported in Refs. 1–4 were concerned with the linear PVE in *p*-type gallium arsenide. The linear PVE in these crystals, observed at $T > 200$ K in the hole density range $p = 10^{15} - 10^{18} \text{ cm}^{-3}$ on excitation with CO₂ laser radiation, is due to transitions between branches of the degenerate Γ_8 valence band. A calculation of the photocurrent associated with the appearance of a directional carrier velocity (ballistic contribution)², when optical transitions occur between the branches of the heavy and light holes and involve participation of optical phonons, and a calculation of the current associated with the displacement or shift of photoholes in real space (shift contribution) when these holes are scattered by phonons^{3,4} yield a value in good agreement with the experiments. These mechanisms of the PVE make it possible to explain the observed dependence of the photocurrent on the hole density and on temperature.

The interest in the influence of a magnetic field on the PVE, manifested in the earlier studies of such effects, is due to the possibility of obtaining information on the kinetic properties of nonthermalized carriers. The interest in the problem has increased when the symmetry considerations were used⁵ to show that in a magnetic field \mathbf{H} we can expect not only the usual Hall component of the photocurrent at

right angles to \mathbf{H} and \mathbf{j} when $H = 0$, but also currents along non-Hall directions governed by the crystal symmetry. For example, in the case of crystals of the symmetry class T_d , which include GaAs, the general expression for the PVE current including the component independent of the magnetic field as well as the terms linear in \mathbf{H} , is as follows:

$$j_\alpha = IX \{ \delta_{\alpha\beta\gamma} (e_\beta e_\gamma^* + e_\gamma e_\beta^*) / 2 + IS_1 [e_\alpha (H_{\alpha+1} \dot{e}_{\alpha+2} - H_{\alpha+2} \dot{e}_{\alpha+1}) - e_\alpha^* (H_{\alpha+1} e_{\alpha+2} - H_{\alpha+2} e_{\alpha+1})] + IS_2 H_\alpha (|e_{\alpha+1}^*|^2 - |e_{\alpha+2}|^2) + I\Gamma | \delta_{\alpha\beta\gamma} | \kappa_\beta H_\gamma^* \} \quad (1)$$

where I is the intensity of the exciting light; \mathbf{e} is the polarization vector of this light; the pseudovector $\boldsymbol{\kappa} = i[\mathbf{e}\mathbf{e}^*] = P_c \mathbf{q}/q$ determines the degree of the circular polarization of light P_c ; \mathbf{q} is the wave vector of a photon; X is the only linearly independent component of the tensor in the case of the linear PVE in a crystal with the symmetry T_d ; Γ is a component of a tensor of third rank for the circular PVE in a magnetic field. The indices in Eq. (1) label the principal axes of the crystal and it is assumed they are subject to cyclic transposition. The first term in Eq. (1) is the component j_0 of the linear PVE independent of \mathbf{H} ; the second component is the current in the Hall direction; the third represents the non-Hall component of the linear PVE, directed along the magnetic field; the last term is the magnetic-field-induced circular PVE. The last component of the current differs from the photocurrent in $H = 0$ because its direction changes with the sign of the circular polarization of light.

We shall report the results of experimental and theoretical investigations of the magnetically induced photogalvanic current in *p*-type GaAs. We shall present first the results of our experimental investigation and follow this with a discussion and identification of the physical nature of the observed effects. Some of the results given below had already been reported.^{6,7}

2. EXPERIMENTAL INVESTIGATION OF THE LINEAR PHOTOVOLTAIC EFFECT IN A MAGNETIC FIELD

A Q-switched CO₂ laser generating radiation pulses of 10.6 μm wavelength, 150 ns duration, and up to 5 kW power was used as the excitation source. The magnetic-field-induced PVEs in zinc-doped p-type GaAs crystals were investigated.

The non-Hall component of the linear PVE was investigated in a longitudinal geometry: $\mathbf{H} \parallel \mathbf{j} \parallel \mathbf{q}$ (Fig. 1a). It follows from Eq. (1) that, in addition to the current representing the drag of electrons by photons and the current due to the linear PVE in a magnetic field, there should be also a photocurrent governed by the constant S_2 :

$$j_{[100]} = IT_p + I\alpha \sin 2\theta + IS_2 H \cos 2\theta, \quad (2)$$

where T_p is a constant governing the drag effect; θ is the angle between the polarization vector of the incident radiation and the [001] direction.

Since the magnetic-field-induced effect should, according to the theoretical estimates, be small compared with the PVE current when $H = 0$, we can reduce Eq. (2) to the form

$$j_{[100]} = IT_p + I\alpha \sin(2\theta + S_2 H / \alpha). \quad (3)$$

We used the differential method for determination of the magnetic-field-induced linear PVE. We employed the apparatus shown in Fig. 1b. Linearly polarized radiation from the CO₂ laser was transmitted by a Fresnel prism made of NaCl, which transformed it into circularly polarized radiation; it then reached a quarter-wave plate made of CdSe which was rotated at a frequency $f = 23 \text{ s}^{-1}$. Next, this lin-

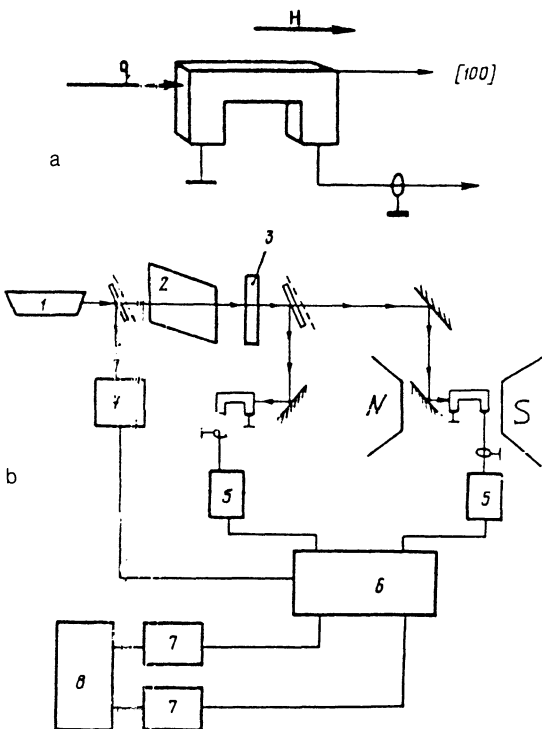

FIG. 1. a) Experimental geometry. b) Schematic diagram of the apparatus used in investigations of the non-Hall linear photovoltaic effect: 1) pulsed CO₂ laser; 2) Fresnel prism made of NaCl; 3) rotatable quarter-wave plate made of CdSe; 4) Ge:Au photodetector; 5) wide-band amplifier; 6) S7-12 sampling oscilloscope; 7) U2-6 selective amplifier; 8) F2-16 meter used to measure the phase shift.

early polarized radiation, but with the plane of polarization rotating at a frequency f , reached the investigated sample subjected to a magnetic field. The split-off part of the radiation flux was directed to a similar sample which was outside the range of action of the magnetic field. The signals from both crystals were amplified and they reached the inputs of different channels of an S7-12 sampling oscilloscope, synchronized by pulses from a Ge:Au photodetector. Analog output signals from the first and second channels of the oscilloscope passed through two selective amplifiers of the U2-6 type and then reached the inputs of an F2-16 meter, which measured the phase shift. The amplifiers were tuned to the second harmonic of the frequency f , i.e., to the frequency 46 s^{-1} , so that it was possible to determine a signal which was entirely due to the magnetic-field-induced linear PVE.

In the absence of a magnetic field a small phase shift (0.2°) was recorded: it was due to slight nonidentity of the electronic circuits in the first and second channels. The application of a magnetic field resulted in an additional phase shift, which was a linear function of the magnetic field intensity (Fig. 2). For a sample with a hole density $p = 2.3 \times 10^{16} \text{ cm}^{-3}$ this shift amounted to 3.2° in a field $H = 6.9 \text{ kOe}$ at $T = 300 \text{ K}$. Estimates of the phase shift due to a possible (in this Faraday-effect geometry) was made allowing for the data reported in Ref. 8 and the result was almost two orders of magnitude greater than the observed value. This led us to the conclusion that the observed phase shift was due to the magnetic-field-induced linear PVE. In the case of the sample with $p = 2.3 \times 10^{16} \text{ cm}^{-3}$ the constant S_2 was $10^{-12} \text{ A} \cdot \text{W}^{-1} \cdot \text{Oe}^{-1}$. Determination of the hole-density dependence indicated an increase in the constant S_2 when this density increased. The temperature dependence was also recorded: when the temperature was lowered from 300 to 78 K, the value of S_2 decreased approximately by a factor of 2.7.

We also measured the linear PVE current in the Hall direction. In a magnetic field $H = 6.9 \text{ kOe}$ this current was $\sim 5\%$ of the linear PVE current in zero field.

3. EXPERIMENTAL INVESTIGATION OF THE MAGNETIC-FIELD-INDUCED CIRCULAR PHOTOVOLTAIC EFFECT

We investigated experimentally the magnetic-field-induced circular PVE using samples made of the same materi-

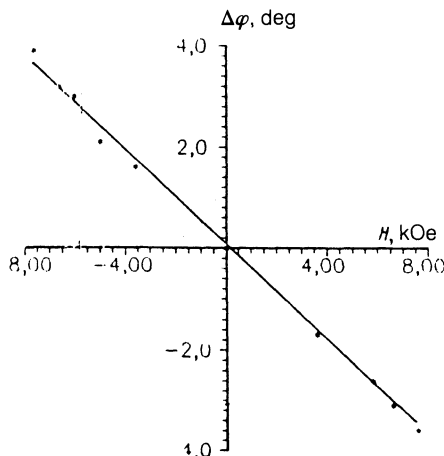

FIG. 2. Dependence of the additional phase shift $\Delta\varphi$ at the inputs of the F2-16 meter on the applied magnetic field, determined at $T = 300 \text{ K}$ for a sample with $p = 2.3 \times 10^{16} \text{ cm}^{-3}$.

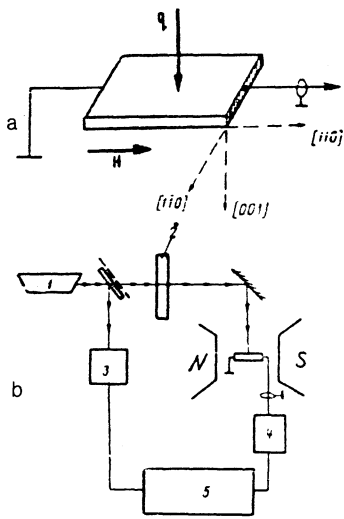

FIG. 3. a) Experimental geometry. b) Schematic diagram of the apparatus used to investigate the magnetic-field-induced circular photovoltaic effect: 1) pulsed CO₂ laser; 2) CdSe quarter-wave plate; 3) Ge: Au photo-detector; 4) wide-band amplifier; 5) S7-12 sampling oscilloscope.

al as those employed in the experiments on the linear PVE. The orientation of a sample and the experimental geometry are shown in Fig. 3a. In this case, it follows from Eq. (1) that the circular PVE current should be

$$j = I\Gamma H P_c \quad (4)$$

Linearly polarized CO₂ laser radiation was converted, by passing it through a quarter-wave plate, into circularly polarized radiation with the degree of the circular polarization amounting to

$$P_c = \sin 2\varphi \quad (5)$$

where φ is the angle between the optic axis of the quarter-wave plate and the polarization vector of the CO₂ laser radiation.

The photocurrent described by Eq. (4) was detected experimentally using the setup shown in Fig. 3b. In the absence of a magnetic field there was practically no signal. In a magnetic field the illumination of a sample with the laser radiation generated a fast-response photo-emf at the contacts and this photo-emf repeated exactly the laser pulse profile. The observed photo-emf depended on the orientation of the optic axis of the quarter-wave plate in accordance with $\sin 2\varphi$ and its sign was reversed on reversal of the sign of the circular polarization of the exciting radiation. Moreover, the sign of the signal changed with the magnetic field direction (Fig. 4). These observations allowed us to attribute the observed fast-response photo-emf to the magnetic-field-induced circular PVE.

The circular PVE current obtained in $H = 6.9$ kOe was only 3.7 times less than the linear PVE current recorded when $H = 0$. The constant Γ amounted to 8.4×10^{-12} A·W⁻¹·Oe⁻¹ at $T = 300$ K when the hole density was $p = 2.3 \times 10^{16}$ cm⁻³.

It should be pointed out that no magnetic-field-induced circular PVE was observed in *n*-type GaAs crystals excited with the CO₂ laser radiation, indicating that the effect was related to transitions between the heavy- and light-hole subbands of the band Γ_8 .

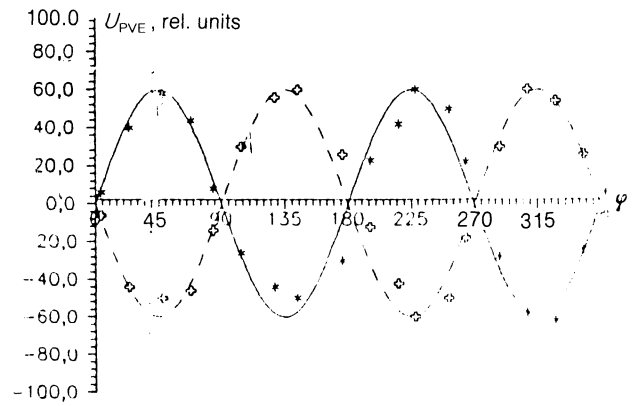

FIG. 4. Dependence of the signal representing the circular photovoltaic effect on the angle between the optic axis of the quarter-wave plate and the polarization vector of the radiation, determined at $T = 300$ K for a sample with $p = 2.3 \times 10^{16}$ cm⁻³; the stars correspond to $H = +6.9$ kOe and the crosses correspond to $H = -6.9$ kOe.

The temperature dependence of the magnetically induced circular PVE is shown in Fig. 5. It could be related to a redistribution of holes between the valence band and the Zn impurity level and also to the temperature dependence of the momentum relaxation time. We also studied the dependence of the effect on the hole density. The hole-density dependences of the quantity Γ and of the conductivity σ were determined at $T = 300$ K (Fig. 6). The value of Γ for $p < 10^{18}$ cm⁻³ increased on increase in the hole density, but the rate of increase was sublinear. At $p \approx 4 \times 10^{18}$ cm⁻³ the value of Γ passed through a maximum and a further increase in the density of holes caused a reduction in Γ . The conductivity σ increased linearly with p in the range $p < 10^{18}$ cm⁻³ and then the rise slowed down so that at $p > 4 \times 10^{18}$ cm⁻³ the conductivity reached a constant value. Characteristically, saturation of the dependence $\sigma(p)$ and the maximum of the dependence $\Gamma(p)$ occurred in the same range of the hole densities.

4. MECHANISMS OF THE NON-HALL PHOTOVOLTAIC CURRENT

As shown in Refs. 3 and 9, the photovoltaic current along the non-Hall directions—which were not governed by the directions of the magnetic field and the current when

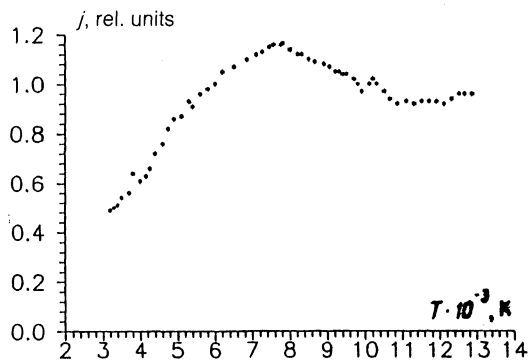

FIG. 5. Temperature dependence of the current due to the circular photovoltaic effect recorded at $T = 300$ K for a sample with $p = 2.3 \times 10^{16}$ cm⁻³.

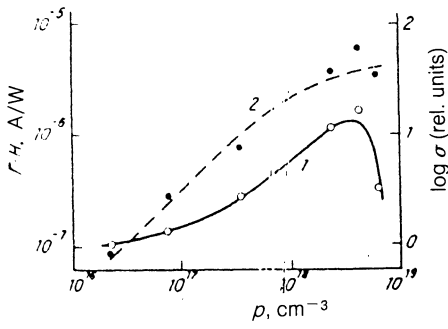

FIG. 6. Dependences of the value of Γ governing the current due to the circular photovoltaic effect, and of the conductivity σ on the density of holes at $T = 300$ K.

$H = 0$, but were determined by the crystal symmetry—could be due to two factors. First, in the case of direct optical transitions between the subbands we can expect alignment of the hole momenta and the polarization dependence of the distribution function is then

$$f_{\mathbf{ek}} \propto (\mathbf{oe})^2, \quad (6)$$

where $\mathbf{o} = \mathbf{k}/k$ and \mathbf{k} is the quasiwave vector of the holes. In a magnetic field \mathbf{H} the component of the distribution function proportional now to $o_x o_y$, is

$$f_{\mathbf{ek}}^{(o_x o_y)} \propto o_x o_y \begin{cases} \frac{2e_x e_y - 2\beta_l^{(z)}(e_x^2 - e_y^2)}{1 + (2\beta_l^{(z)})^2} & \mathbf{H} \parallel z, \\ \frac{2e_x e_y + 2\beta_l^{(x)} e_x e_z}{1 + (2\beta_l^{(x)})^2}, & \mathbf{H} \parallel x. \end{cases} \quad (7)$$

$$(8)$$

where

$$\beta_l^{(i)} = \Omega_{c,i}^{(l)} \tau_p^{(l)}, \quad \Omega_{c,i}^{(l)} = qH_i / m_l c,$$

and m_l and $\tau_p^{(l)}$ are, respectively, the mass and relaxation time of holes in the subband l .

In zero magnetic field the anisotropic component of the distribution function of Eq. (6), proportional to $o_x o_y e_x e_y$, gives rise to a linear PVE current in the $\mathbf{z} \parallel [100]$ direction. The current is due to the carrier scattering asymmetry or the shift of the carrier wave packet in real space at the moment of scattering. It follows from Eqs. (7) and (8) that in a magnetic field the asymmetric scattering or shift induce a photovoltaic current along the Hall and non-Hall directions.

Second, in a magnetic field the linear PVE along the z axis acquires not only a component $f_{\mathbf{ek}}$, proportional to $o_x o_y$, but also a component proportional to $(o_x^2 - o_y^2)(e_x^2 - e_y^2)$. If in $H = 0$ the asymmetry of the probability of the scattering of holes with a given component of the distribution function or the average shift of holes are absent, then in $H \neq 0$ an allowance for the quantum corrections, in terms of the parameter $\alpha = \hbar\omega_c / E_{\text{kin}}$ (ω_c is the angular frequency and E_{kin} is the characteristic kinetic energy of holes), to the probability of the scattering of holes involving one phonon gives rise to a contribution to the photocurrent.

Both contributions to the investigated effect are of comparable orders of magnitude. In spite of the fact that in the

case of the first contribution the appearance of the current is associated with the action of the magnetic field which is related to the large classical parameter β_l , the intrinsic probability asymmetry is due to the interference between two transitions; i.e., it is due to an allowance for the quantum corrections in terms of the parameter $\gamma_l = \hbar / \tau_p^{(l)} E_{\text{kin}}$. In both cases the magnetically induced current is governed by the parameter $\alpha_l = \gamma_l \beta_l$.

In the case of the transitions between the subbands of the degenerate valence band Γ_8 there is an additional mechanism that can give rise to a current along a non-Hall direction: this is the asymmetry of the probability of direct optical transitions induced by the applied magnetic field. We shall consider the nature of this mechanism by recalling the situation in the case of the current along a Hall direction.^{9,10}

In zero magnetic field the asymmetry of the probability of optical transitions is due to interference of the transitions involving participation of phonons and the direct transitions, and it is governed by the parameter γ_l . In a magnetic field the twisting of the carrier paths means that this asymmetry gives rise to a current governed by the parameter $\alpha_l = \gamma_l \beta_l$.

Moreover, the magnetic field itself induces a distribution asymmetry due to direct optical transitions and unrelated to the interference with transitions involving the scatterers. This is due to the fact that the magnetic field gives rise to an uncertainty of the transverse momentum of the carriers and thus behaves as a third body. This asymmetry is once again governed by the same parameter α_l and as a final result both these contributions to the current along a Hall direction are comparable.

We shall now consider the current of holes in a Hall direction. The asymmetry of the hole distribution induced by a magnetic field (i.e., unrelated to the interference between the direct optical transitions and the transitions involving the scatterers) gives rise to an effect in a non-Hall direction. This result is a consequence of the structure of the degenerate valence band. In the case of a simple band structure in Ref. 10 the magnetically induced asymmetry of the optical transitions does not give rise to a current along a non-Hall direction.

We can see that for all these mechanisms the non-Hall and Hall linear PVEs are comparable in respect of their order of magnitude. The difference between these effects and the current in the absence of a magnetic field is characterized, like the Hall effect, by the parameter β_l . The experimental results revealing a current in a non-Hall direction are in full agreement with this conclusion.

The experimentally observed temperature and hole-density dependences of the photocurrent do not allow us to state with certainty which of these contributions to the current along a non-Hall direction predominates. However, we can draw the conclusion that, as in the case discussed in Refs. 2–4, the relaxation time of the hole momentum is governed by the scattering on phonons and the absorption of light is associated with free holes. The asymmetry of the distribution of the hole momentum is then related either to the direct optical transitions in a magnetic field or it is due to the interference with the phonon-assisted transitions.

Moreover, the existence of a shift contribution to the current, associated with the scattering of holes by phonons in the case when the holes are aligned optically is not in

conflict either with the hole-density and temperature dependences of the non-Hall linear PVE. However, a comparison of the strong temperature dependence of the linear PVE observed in $H = 0$ [which is related—as shown in Ref. 2—to the asymmetry of the scattering of holes by optical phonons when cooling from $T = 300$ K to $T = 78$ K reverses the sign of the photocurrent and increases it by a factor of 2.5] with the results of measurements of the non-Hall current, which at 78 K has the same sign as at 300 K, demonstrates that in the case of the non-Hall current the contributions due to the above-mentioned asymmetry play a smaller role than in the case of the linear PVE when $H = 0$. This may be due to partial compensation of the contributions associated with the magnetically induced phonon scattering asymmetry by the contributions due to the asymmetry or the shift of holes characterized by the anisotropic distribution [Eqs. (7) and (8)]. This is because the latter are the physical cause of both the appearance of the current when $H = 0$ and of the non-Hall current, whereas the magnetically induced asymmetry is naturally absent when $H = 0$. If such a compensation does occur, we may conclude that a significant contribution to the magnitude of the effect comes from the magnetically induced asymmetry of the distribution of the hole momentum in the case of direct optical transitions between the heavy- and light-hole subbands. Another cause of the difference between the temperature dependences of the linear PVE current when $H = 0$ and the current in a non-Hall direction may be a change in a magnetic field, at temperatures below 150 K, of the relationship between the processes of asymmetric scattering by impurities and by phonons. As a result, in both cases an explanation of the experimental data must allow for the occurrence of asymmetric electron processes induced by the applied magnetic field.

5. MECHANISM OF THE MAGNETICALLY INDUCED CIRCULAR PHOTOVOLTAIC EFFECT

Since in zero magnetic field the asymmetric part of the distribution function, governing the directional velocity of holes, or the anisotropic part, governing their average shift in real space as a result of scattering, are both independent of the degree of the circular polarization of the incident radiation, it therefore seems at first sight that the bending of the paths under the action of the Lorentz force cannot give rise to the circular PVE in a magnetic field. An analysis was therefore made in Refs. 11 and 12 of the contribution to the circular PVE current in a magnetic field by the quantum corrections to the probability of optical transitions which are proportional to α_7 . Calculations indicate that the effect associated with the quantum corrections represents only 10% of the experimentally observed value.

It was shown in Refs. 7 and 13 that the observed effect is due to the cubic (in \mathbf{k}) spin splitting of the band states in noncentrosymmetric crystals. In the presence of such spin splitting, which depends on the direction of the carrier momentum, there is a kinetic mechanism of the magnetically induced circular PVE due to a change in the photocarrier momentum distribution under the action of the Lorentz force or under the influence of the spin precession in a magnetic field.

We shall now give the principal relationships that govern the quantitative calculations and the contributions to the current, and then we shall interpret the results qualitatively.

The magnetically induced current of the circular PVE is described by the following expression for the ballistic contribution:

$$\mathbf{j} = e \sum_{\mathbf{k}} \text{Sp } \mathbf{V}_{\mathbf{k}} \rho_{\mathbf{k}}, \quad (9)$$

where $\rho_{\mathbf{k}}$ is a 4×4 density matrix of holes; $\mathbf{V}_{\mathbf{k}} = \hbar^{-1} \nabla_{\mathbf{k}} \mathcal{H}$ is the hole velocity operator. In the effective Hamiltonian \mathcal{H} of the band Γ_8 we shall include not only the usual contribution

$$\mathcal{H}^{(2)} = \frac{\hbar^2}{2m_0} \left[\left(\gamma_1 + \frac{5}{2} \gamma \right) k^2 - 2\gamma (\mathbf{J}\mathbf{k})^2 \right], \quad (10)$$

which governs the effective masses of holes, but also the terms cubic in \mathbf{k} :

$$\mathcal{H}^{(3)} = D \sum_{\alpha} J_{\alpha} k_{\alpha} (k_{\alpha+1}^2 - k_{\alpha+2}^2), \quad (11)$$

which determine the spin splitting of the light- and heavy-hole branches. Here, J_{α} is the angular momentum matrix; $\alpha = x, y, z$ are the principal axes of the investigated crystal; γ_1 and γ are the Luttinger parameters; D is the constant representing the spin splitting of the subbands. The projections of the momentum J_{α} onto the direction of the wave vector in the case of the subband of heavy holes with the energy $E_1 = (\hbar^2 k^2 / 2m_0) (\gamma_1 - 2\gamma)$ are $m = \pm 3/2$, whereas the projections of the subband of light holes with an energy $E_2 = (\hbar^2 k^2 / 2m_0) (\gamma_1 + 2\gamma)$ are $m = \pm 1/2$; here, m_0 is the mass of a free electron.

The density matrix of holes $\rho_{\mathbf{k}}$ is described by the kinetic equation

$$G_{\mathbf{k}} + I_{\text{coll}}(\rho_{\mathbf{k}}) = \frac{q}{\hbar c} \{ [\mathbf{V}\mathbf{H}] \nabla_{\mathbf{k}} \rho_{\mathbf{k}} \} + \frac{i}{\hbar} [2\kappa_0 \mu (\mathbf{J}\mathbf{H}) + \mathcal{H}^{(2)} + \mathcal{H}^{(3)}, \rho_{\mathbf{k}}], \quad (12)$$

where I_{coll} is the collision operator; $G_{\mathbf{k}}$ is the photohole generation matrix; μ is the Bohr magneton; κ_0 is the Luttinger constant; $\{ \dots \}$ and $[\dots, \dots]$ represent, respectively, the symmetrization and the commutator of the operators.

The component of the hole photogeneration matrix proportional to the degree of the circular polarization of the exciting light is, in accordance with the selection rules governing the matrix elements of a transition between the valence band branches, described by

$$G_{\mathbf{k}}^{\circ} = W^{\circ} \left[\frac{1}{2} (J_0) P_1 - 2 (J_0) P_2 \right], \quad (13)$$

where

$$P_1 = \frac{1}{2} [(J_0)^2 - 1], \quad P_2 = \frac{1}{2} [3 - (J_0)^2]$$

are the operators of projection onto a state in the heavy- and light-hole subbands, respectively; W° is the component—dependent on P_c —of the probability of an optical transition between the subbands. The photogeneration matrix has non-zero components only for the states inside the heavy- and light-hole subbands. All the off-diagonal matrix elements vanish.

In a calculation of the magnetically induced circular PVE it was necessary to solve the kinetic equation (12) and to calculate the contribution, proportional to the magnetic field and the spin splitting constant, made to the photohole

density matrix. The final result for the constant Γ in Eq. (1) describing the circular PVE current is as follows:

$$\Gamma = \Gamma_1 + \Gamma_2, \quad \Gamma_i = q \frac{k}{\hbar \omega} (\tau_{p,i}^{(l)})^2 \frac{\Omega_c^l}{H} \frac{Dk_0^2}{10\hbar} C_i. \quad (14)$$

Here, k is the optical absorption coefficient for transitions between the heavy- and light-hole subbands; $\tau_{p,i}^{(l)}$ is the relaxation time of the component of the redistribution function of the momentum of holes in the subband l described by spherical harmonics of the i th order; $k_0 = (1/\hbar)(\hbar\omega m_0/\gamma)^{1/2}$ is the wave vector governed by the laws of conservation of energy in an optical transition; the coefficients C_i are given in Ref. 7. The contribution to the effect is made by both light and heavy holes. The fact that the result contains only the parameters of just the light or just the heavy holes in each of the terms and does not include the terms proportional to the product of the relaxation times of heavy holes and of the relaxation time of light holes is not purely accidental, but reflects the physical nature of the investigated photocurrent mechanism.

6. QUALITATIVE DESCRIPTION OF THE EFFECT

The circular PVE current is determined by two factors.

The first factor is related to the appearance of a correlation between the momentum and the spin of holes when the investigated sample is illuminated with circularly polarized light. The corresponding generation function is given by Eq. (13) and relaxation of the resultant anisotropic component of the distribution function occurs in a time $\tau_{p,2}^{(l)}$, which is the relaxation time of that component of the distribution function which is described by the second Legendre polynomial.

The second factor is the effect of a magnetic field. In a magnetic field both light and heavy holes experience the Lorentz force. The correction to this force due to the spin splitting of the branches, which is a cubic function of \mathbf{k} , is then

$$\Delta F_k(l) = \frac{q}{c} [\Delta V^{(l)} \mathbf{H}], \quad (15)$$

where

$$\Delta V_\alpha^{(l)} = \frac{1}{\hbar} \frac{\partial \omega_\alpha}{\partial k_\alpha} P_l J_\beta P_l, \quad \omega_\alpha = Dk_\alpha (k_{\alpha+1} + k_{\alpha-1}),$$

and P_l is the operator representing the projection onto states in the subband l .

In contrast to the usual component of the Lorentz force responsible for the torque which acts on the momentum distribution of holes (Fig. 7a), the correction to this force is an even function of the wave vector and generally shifts the center of gravity of the distribution of holes (Fig. 7b) and gives rise to a magnetically induced photocurrent.

However, we must bear in mind that since the effect under consideration is due to a component of the photogeneration matrix [the first term within the square brackets in Eq. (13) represents heavy holes, and the second represents light holes], it follows that after averaging over all the directions of the wave vector the force acting on both heavy and light holes vanishes. In particular, in spite of the fact that (as demonstrated in Fig. 7b) a component of the average force directed along the positive y axis appears in the (k_x, k_y) plane after summation over all the values of \mathbf{k} , it is found that this component is compensated completely by the compo-

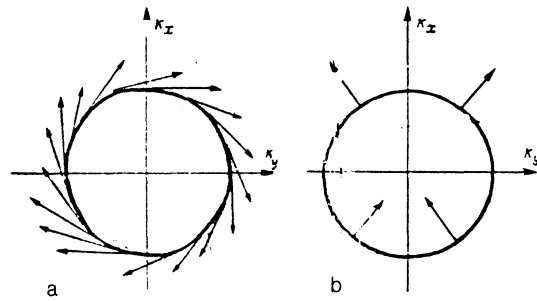

FIG. 7. Lorentz force in noncentrosymmetric crystals: a) usual component responsible for twisting of carrier paths; b) correction which shifts the center of gravity of the momentum representation.

nent of the force that appears when holes are considered in the (k_y, k_z) plane.

Nevertheless, the influence of the Lorentz-force correction on the momentum distribution of holes gives rise to a current because the mean free time (the time taken to travel the mean free path) depends on energy.

The mean free time of a photoelectron with a wave vector \mathbf{k} can be written in the form

$$t_h = \int_0^\infty dt \exp \left[- \int_0^t \frac{dt'}{\tau(\mathcal{E}(t'))} \right],$$

where $\tau(\mathcal{E}(t))$ allows for the relaxation time of holes as a function of their energy, which changes under the influence of the field.

Although the applied magnetic field does not influence the average energy of holes (we have in mind here the averaging over the angles and orientation in respect of the spin) in the case of the investigated energy band structure, in the case of any specific direction of the momentum and projection of the spin the energy changes in the magnetic field. If we write down the current in the form

$$j = q \sum S_p G_h^{(l)} V^{(l)} t_h^{(l)}$$

and allow for the fact that in the first order in terms of the correction to the force $\Delta \mathbf{F}$, we have

$$t_h = \tau \left(- \frac{\partial \tau}{\partial \mathcal{E}} \frac{\hbar k_\alpha}{m^*} q \Delta F_\alpha \right)$$

which gives the contribution of the current related to the effect of the correction to the Lorentz force (m^* is the effective mass of carriers).

Although the number of carriers which appear in a state with wave vectors \mathbf{k} and $-\mathbf{k}$ is the same, because G_k is an even function of the wave vector [Eq. (13)], the mean free time of holes at these points differs because of the action of the force. There is a corresponding uncompensated contribution to the current, which does not vanish after averaging over all the wave vectors, in contrast to the force $\Delta \mathbf{F}$.

However, the effect of a magnetic field is not limited to the spin-dependent component of the force, but is also related to the usual component of the Lorentz force which rotates the momentum distribution of carriers and to the Larmor precession of the spin. We have to allow for the correction to the velocity in the expression for the current in Eq. (9) due

to the cubic spin splitting of the subbands. This correction is an even function of the wave vector, like the distribution function describing the correlation between the momentum and the spin of holes. However, in the absence of a magnetic field the correlation between the momentum and spin of the optically excited holes is such that the corrections ΔV do not give rise to a photocurrent, in full agreement with the symmetry considerations. It is important to note that the contributions to the current of carriers with the wave vectors \mathbf{k} and $-\mathbf{k}$ have the same sign and also that the total current, proportional to the degree of circular polarization, vanishes after summation over all the directions of the wave vector. (In studies of the photovoltaic effect it is usual to assume that the asymmetry that gives rise to the current is associated with compensation of the contributions made to the current by carriers with the wave vectors \mathbf{k} and $-\mathbf{k}$.)

In a magnetic field, as a result of the orbital motion of holes under the influence of the Lorentz force or because of spin precession around the direction of \mathbf{H} , the correlation between the momentum and the spin of holes is modified and the compensation of the contributions to the current of holes with all possible directions of \mathbf{k} is lost and a magnetically induced circular PVE is observed.

7. COMPARISON OF THE THEORY AND EXPERIMENT

If we assume that the main mechanism of the scattering of holes at $T = 300$ K is the interaction with optical phonons and if we bear in mind the polar and deformation mechanisms of momentum relaxation in the case of the circular PVE current¹⁴ induced by the CO_2 laser radiation with the photon energy $\hbar\omega = 117$ meV, we find that if the effective masses of holes are $m_1 = 0.51m_0$ and $m_2 = 0.09m_0$ and the value of the splitting constant—which is a cubic function of \mathbf{k} —is $D = 39 \text{ eV} \cdot \text{Å}^3$ (Ref. 15), we obtain $\Gamma = 6 \times 10^{-12} \text{ Å/W}$, which is 70% of the value obtained experimentally.

The calculated value of the PVE current in a field $H = 25$ kOe, when $\Omega_c^{(1)}\tau_p^{(1)} = 0.12$, is indeed comparable with the linear PVE current in $H = 0$ and is an order of magnitude higher than the linear PVE currents along the non-Hall and Hall directions. This is in full agreement with the postulate that the directional velocity of the carriers giving rise to the linear PVE does not appear in the case of direct optical transitions between the subbands and it is necessary to allow for the interference between optical transitions and scattering process in the first order of the parameter $(\hbar/\tau_p)(1/E_{\text{kin}}) \sim 0.1$ (the same parameter is used to characterize, in the final analysis, also the shift component of the linear PVE).

This mechanism of the circular PVE is related to direct transitions between the subbands and the effect of the applied magnetic field is represented by the parameter $\Omega_c\tau_p$. The values of the Hall and non-Hall contributions to the linear PVE are represented by a product of two parameters: $(\hbar/\tau_p E_{\text{kin}})(\Omega_c\tau_p)$. If we bear in mind that each of these effects—the circular PVE, the linear PVE when $H = 0$, and the Hall and non-Hall contributions to the linear PVE—is related in the same way to the asymmetry and the parameter of this asymmetry is, for example, Dk_0/H , it becomes clear that the ratio of the circular and linear PVE currents in $H = 0$ amounts to $E_k \Omega_c \tau_p / (\hbar/\tau_p)$ and the ratio of the circular PVE current to the linear PVE current along the Hall and non-Hall directions is $E_k / (\hbar/\tau_p)$.

Therefore, the unexpected experimental result can be explained in a natural manner and this explanation extends greatly the current ideas on the asymmetry of elementary electron processes in noncentrosymmetric crystals. It should be pointed out that the experimentally recorded values of the Hall and non-Hall contributions are practically identical in the absolute sense, in full agreement with the results of an estimate given above.

We shall now consider the temperature and hole-density dependences of the circular PVE current. The temperature-dependent quantities that govern the circular PVE are the density of holes in the subbands and their relaxation times. An important factor may be the role of the various transitions considered as a function of temperature. In particular, when holes are located mainly at impurities, we can expect impurity–valence band transitions. In this case the photocurrent includes contributions only of the holes in the final state, i.e., of holes in the valence band. This situation differs from the case of an intraband phototransition, because the current includes contributions of spin-oriented holes in the initial and final states. The momentum relaxation mechanism varies with temperature. At high temperatures the holes are scattered on optical phonons and the current decreases on increase in temperature. At lower temperatures the impurities begin to play a role. The observed temperature dependence of the photocurrent is influenced by all these circumstances. The photocurrent associated with the proposed mechanism is proportional to τ_p^2 .

The hole-density dependence of the circular PVE current (Fig. 6) is due to the dependence of the momentum relaxation time and of the density of holes in the subbands on the dopant concentration. At higher dopant concentrations ($N_{zn} > 10^{18} \text{ cm}^{-3}$) the scattering of carriers in GaAs (Ref. 16) is determined largely by the collisions with impurities even at room temperature. We then have $\tau_p \propto 1/N_{zn}$. Therefore, at high dopant concentrations the constant Γ should fall on increase in the hole density. It is clear from Fig. 6 that in the range of the hole densities at which the conductivity σ reaches a constant value the quantity Γ falls steeply on increase in the hole density. This corresponds to the case when the microscopic theory predicts the dependence $\Gamma \propto \tau_p^2$, in contrast to the dependences $\sigma \propto \tau_p$ and $\mu \propto \tau_p$. At low impurity concentrations the scattering is governed by the lattice vibrations and, therefore, the values of σ and Γ increase on increase in the density of holes in the valence band. The difference between these dependences is clearly due to the different energy distributions of holes that govern σ and of photoholes that contribute to Γ .

8. CONCLUSIONS

The reported work is the final stage of a decade-long study of the photo-voltaic-magnetic effects in p -type GaAs. This particular crystal is the only one which exhibits all the photovoltaic effects associated with the asymmetry of elementary electron processes and allowed by the T_d symmetry class: the linear photovoltaic effect in $H = 0$, the Hall and non-Hall linear photovoltaic effects in a magnetic field, and the magnetically induced circular effect. There is a reasonable qualitative and quantitative agreement between the experiment and theory in the case of the effects observed in the infrared range and induced by laser radiation. Our results

show that, depending on the hole density and temperature, the investigated effects may be associated with the asymmetry of the scattering of holes by phonons or impurities, and also with the asymmetry of the interaction with radiation.

The investigations altered considerably our ideas on the asymmetry. We found that the currents along the Hall and non-Hall directions are comparable. It was also found that the characteristic features of the dynamics of particles with spin noncentrosymmetric crystals make the magnetic-field-induced circular photovoltaic effect (absent in $H = 0$) an order of magnitude greater than the Hall and non-Hall currents, associated with rotation of the distribution function responsible for the linear photovoltaic effect in $H = 0$.

Investigations of the linear photovoltaic effect in the infrared range have made it possible to determine the effect in the submillimeter part of the spectrum and studies of the mechanisms of the circular photovoltaic effect in a magnetic field have led to the prediction of new effects in quantum wells and in superlattices.

¹A. V. Andrianov and I. D. Yaroshetskiĭ, *Pis'ma Zh. Eksp. Teor. Fiz.* **40**, 131 (1984) [*JETP Lett.* **40**, 882 (1984)].

²A. V. Andrianov, E. L. Ivchenko, G. E. Pikus *et al.*, *Zh. Eksp. Teor. Fiz.* **81**, 2080 (1981) [*Sov. Phys. JETP* **54**, 1105 (1981)].

³E. L. Ivchenko, G. E. Pikus, and R. Ya. Rasulov, *Fiz. Tverd. Tela (Leningrad)* **26**, 3362 (1984) [*Sov. Phys. Solid State* **26**, 2020 (1984)].

⁴Yu. B. Lyanda-Geller and R. Ya. Rasulov, *Fiz. Tverd. Tela (Leningrad)* **27**, 945 (1985) [*Sov. Phys. Solid State* **27**, 577 (1985)]; Yu. B. Lyanda-Geller, *Fiz. Tverd. Tela (Leningrad)* **27**, 952 (1985) [*Sov. Phys. Solid State* **27**, 581 (1985)].

⁵E. L. Ivchenko and G. E. Pikus, *Problems in Modern Physics* [in Russian], Nauka, Leningrad (1979), pp. 273–293.

⁶A. V. Andrianov and I. D. Yaroshetskiĭ, *Pis'ma Zh. Eksp. Teor. Fiz.* **40**, 131 (1984) [*JETP Lett.* **40**, 882 (1984)].

⁷Yu. B. Lyanda-Geller, *Fiz. Tverd. Tela (Leningrad)* **31**(6), 150 (1989) [*Sov. Phys. Solid State* **31**, 999 (1989)].

⁸T. H. Lee and H. Y. Fan, *Phys. Rev.* **165**, 927 (1968).

⁹S. B. Astaf'ev, V. G. Lazarev, Yu. B. Lyanda-Geller, and V. M. Fridkin, *Fiz. Tverd. Tela (Leningrad)* **30**, 3362 (1988) [*Sov. Phys. Solid State* **30**, 1932 (1988)].

¹⁰E. L. Ivchenko, Yu. B. Lyanda-Geller, G. E. Pikus, and R. Ya. Rasulov, *Fiz. Tekh. Poluprovodn.* **18**, 93 (1984) [*Sov. Phys. Semicond.* **18**, 55 (1984)].

¹¹E. L. Ivchenko, Yu. B. Lyanda-Geller, and G. E. Pikus, *Fiz. Tverd. Tela (Leningrad)* **30**, 990 (1988) [*Sov. Phys. Solid State* **30**, 575 (1988)].

¹²E. L. Ivchenko, Yu. B. Lyanda-Geller, and G. E. Pikus, *Ferroelectrics* **83**, 19 (1988).

¹³E. L. Ivchenko, Yu. B. Lyanda-Geller, and G. E. Pikus, *Solid State Commun.* **69**, 663 (1989).

¹⁴S. Kh. Esayan, E. L. Ivchenko, V. V. Lemanov, and A. Ya. Maksimov, *Pis'ma Zh. Eksp. Teor. Fiz.* **40**, 462 (1984) [*JETP Lett.* **40**, 1290 (1984)].

¹⁵G. E. Pikus, V. A. Marushchak, and A. N. Titkov, *Fiz. Tekh. Poluprovodn.* **22**, 185 (1988) [*Sov. Phys. Semicond.* **22**, 115 (1988)].

¹⁶F. P. Kesamanly and D. N. Nasledov (eds.), *Gallium Arsenide: Preparation, Properties, and Applications*, Nauka, Moscow (1973), pp. 156–256.

Translated by A. Tybulewicz